

Kelvion

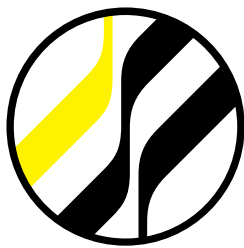

Plate Heat Exchangers

# TAILOR-MADE SOLUTIONS







**Kelvion –  
a tribute to  
Lord Kelvin**

**70 branches and  
sales partners  
worldwide**

**More than 4,000  
employees  
worldwide**

Lord Kelvin (1824 – 1907) formulated  
the laws of thermodynamics

# EXPERTS IN HEAT EXCHANGE – SINCE 1920

Welcome to Kelvion. As successor to the GEA Heat Exchangers Group, we continue to break new ground, making discerning customers more successful than ever with our integrated heat exchanger solutions.

#### **Our solutions for your applications:**

We offer our customers one of the world's largest product portfolios in the field of heat exchangers. It includes individual solutions for practically all conceivable applications and complex environmental conditions: plate heat exchangers, shell and tube heat exchangers, finned tube heat exchangers, modular cooling tower systems, and refrigeration heat exchangers.

#### **Your markets are our markets, too:**

The markets in which you and we together operate are among the most important in the world: the chemical industry, food and beverages, the heavy industry, climate and environment, marine applications, the oil and gas industry, energy, refrigeration technology, sugar and transportation. We provide every single market segment with solutions of outstanding efficiency, safety, and sustainability.

#### **We are highly committed to earning your trust:**

We want to win your trust with everything we do and convince you with the solutions we offer. With this high aim in mind, we invest our extensive know-how, our great precision, and our passion in everything we do: including product development, manufacturing, installation, and after-sales support.

#### **Seeing things from the customer perspective:**

Your specific requirements count – and nothing else. Whatever we offer you, it must meet these requirements. Our entire way of thinking and working is geared towards this aim. Our customers truly appreciate this: after all, this is how we make their companies more efficient.

#### **We are at your service.**

Kelvion – Experts in Heat Exchange.

# TAILOR-MADE SOLUTIONS IN AREA OF APPLICATION AT H

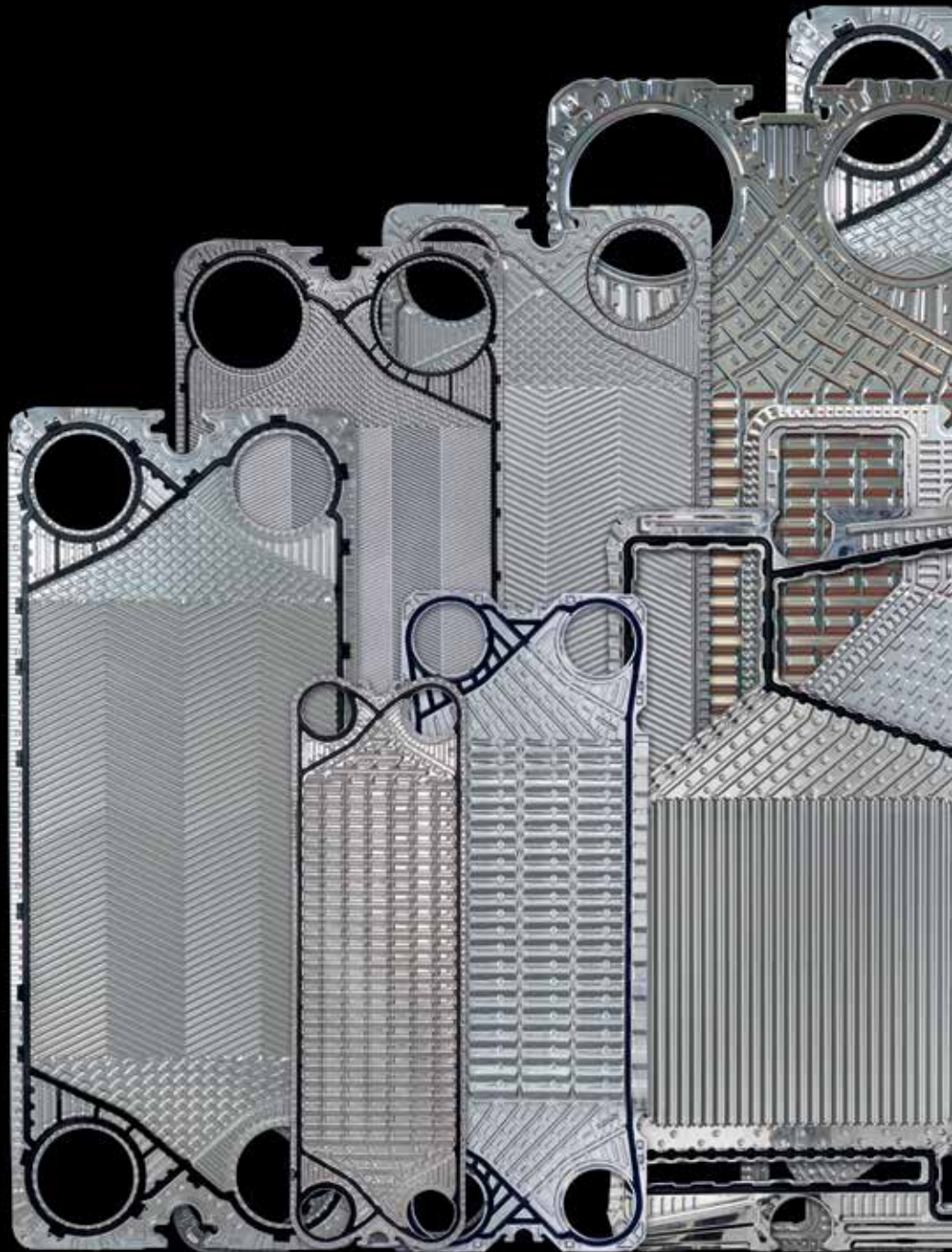

As the worldwide technology leader in the manufacture and development of plate heat exchangers, we have one of the most extensive product ranges on the market. Our product diversity ranges from gasketed to brazed and even fully-weld-

ed plate heat exchangers. This includes process-optimised model ranges that are unique in their number and special functions. This makes us absolute specialists when it comes to developing tailor-made solutions for your applications.

# N EVERY HOME

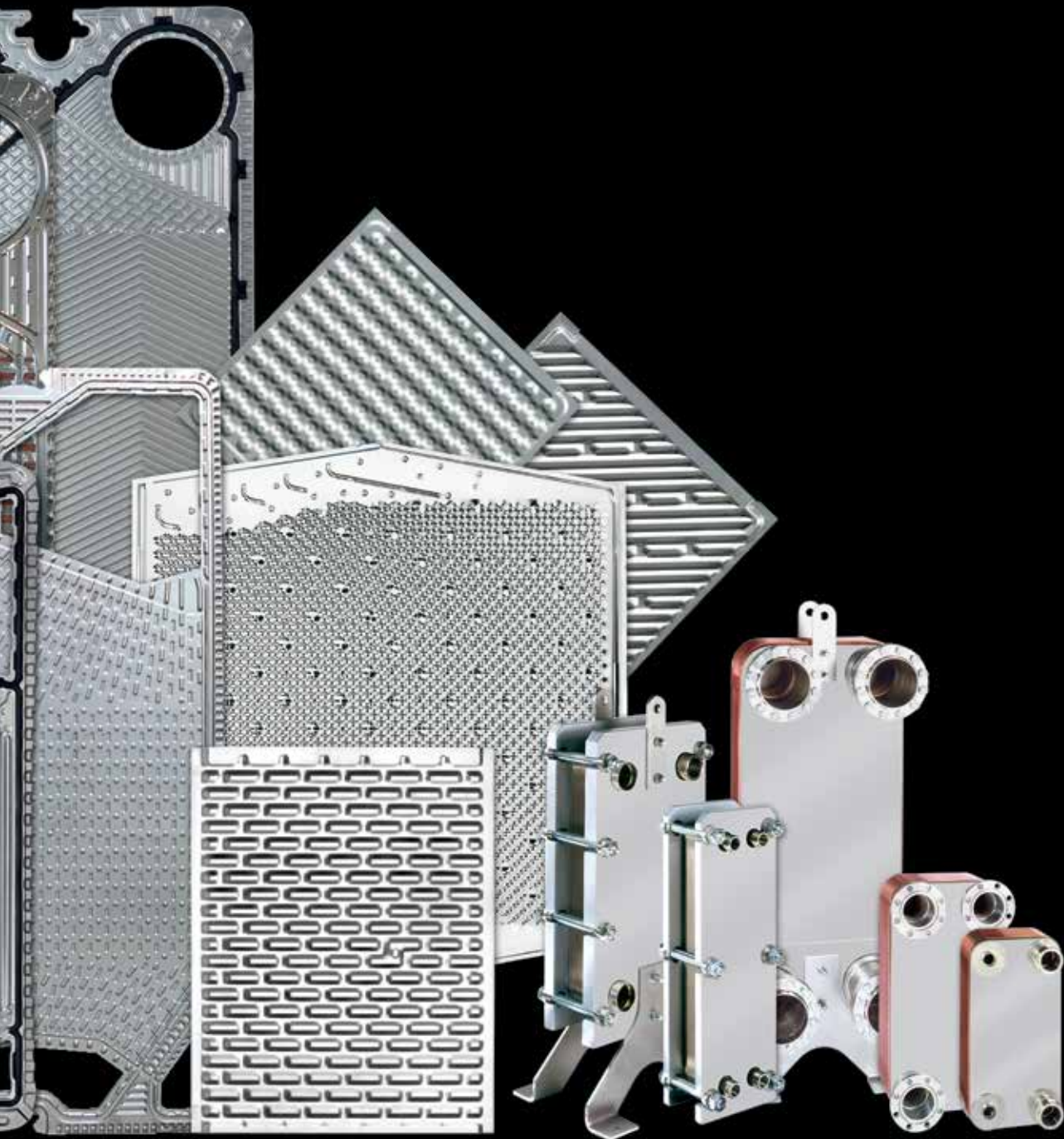

All Kelvion enterprises make an above-average investment in research and development. The organisation and coordination of knowledge transfer plays a leading role in this process. Core competency is thus secured and further

extended. This is to your direct benefit. It is only possible to continuously develop efficient plate types for new fields of application with the aid of extensive research and development work.

# GASKETED PLATE HEAT EXCHANGERS

## THE BENCHMARK OF EFFICIENCY

The gasketed plate heat exchangers reveal what passion, scientific curiosity and technological expertise can achieve. The facts: high efficiency at low operating costs, greater application possibilities at a lower investment costs. Continuous further development of the plate series targeted at the requirement of the thermo- and hydrodynamic industries

also ensure that you can achieve maximum economic efficiency. The range of plate corrugations and plate lengths enables them to be made to measure to your requirements. In addition, maintenance-friendly assembly and sealing technologies are applied, which assure the flawless seating of the gasket and plate package.

### A suitable plate heat exchanger series for each production stage:

	NT Series	NH Series	ND Series	NX Series	NL Series	LWC Series	Free Flow NW Series	Conci-therm	GG Series
<b>Foodstuff industry</b> Our PHEs heat and cool so that in the end it tastes good for everyone.	X		X	X	X	X	X	X	
<b>Sugar industry</b> In the case of sugar cane and beet processing, we ensure that nothing is burned and that primary energy consumption is minimised.	X					X	X	X	
<b>Chemical industry</b> Undertake entire job in critical areas and offer individual solutions for high levels of safety and minimal energy consumption.	X	X	X	X		X	X		
<b>Renewable energy</b> We contribute to the replacement of fossil fuels by sustainable fuels.	X	X			X	X	X		
<b>HVAC</b> (Heating, Ventilation, Air-conditioning, Cooling) We have the technical diversity required for remote heating, refrigeration, air-conditioning, solar, pool and surface technologies.	X	X	X	X		X			X
<b>Energy generation</b> Our PWTs are used for turbine cooling in power stations as well as in the field of power-heat cogeneration.	X	X	X	X					
<b>Heavy industry</b> Whether for steel production, mechanical engineering or in the automotive industry - there is a plate heat exchanger that matches every field of application.	X	X	X	X					
<b>Marine</b> For the cooling of ship propulsion systems and generators and for the air-conditioning of interior spaces.	X	X	X	X		X			
<b>Paper industry</b> We put forward a persuasive case in the energy-intensive pulp and paper production sector with high levels of heat transfer and energy-saving processes.	X						X		
<b>Oil/Gas</b> Gaseous, fluid and dual-phase media are controlled safely by our PHEs, even under extreme conditions.	X	X		X		X			
<b>Refrigeration industry</b> Always stay cool. No matter what must remain refrigerated, we ensure that it takes place as required and cost-effectively.	X					X			

## The N Series

# QUALITY AND FLEXIBILITY AT ITS BEST

You can benefit from the innovative technology of our gasketed plate heat exchangers no matter whether high pressure or harsh operating conditions. For tall buildings or for low investment, operating and service costs. For use with critical media or for high-performance remote refrigeration systems.

Thanks to the technical characteristics and the ability to swap various plate series in the same frames, the N Series offers an extraordinarily broad spectrum of applications – in the broadest range of sectors and for the most diverse media.

### **N for high flexibility**

Even if the medium or requirement changes. There is no greater flexibility: Nearly all of the N series can be used in the same frame and various plate numbers.

### **EcoLoc gasket system**

Done in a matter of moments: Thanks to their glueless EcoLoc gaskets, they can be exchanged quickly and simply.

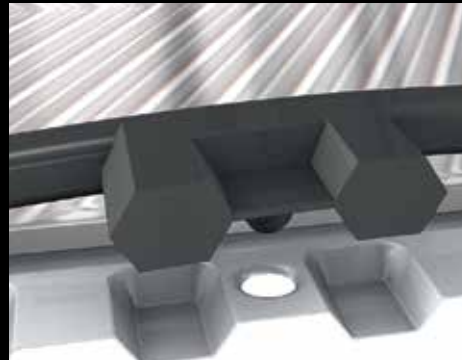
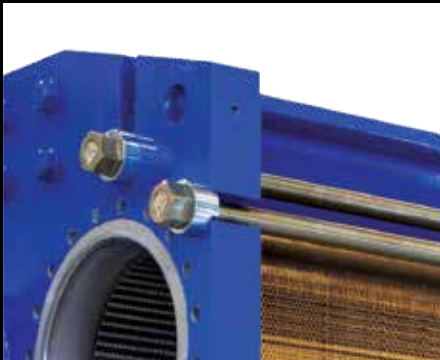

### **OptiWave design**

Optimised corrugation leads to the highest heat transfer rates by means of the uniform distribution of media over the entire width of the plate.

### **PosLoc assembly**

The PosLoc assembly system leads to a stable, perfectly aligned plate package. The gaskets lie exactly alongside each other and remain functional for longer.

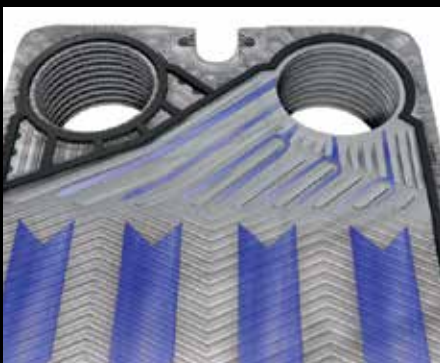

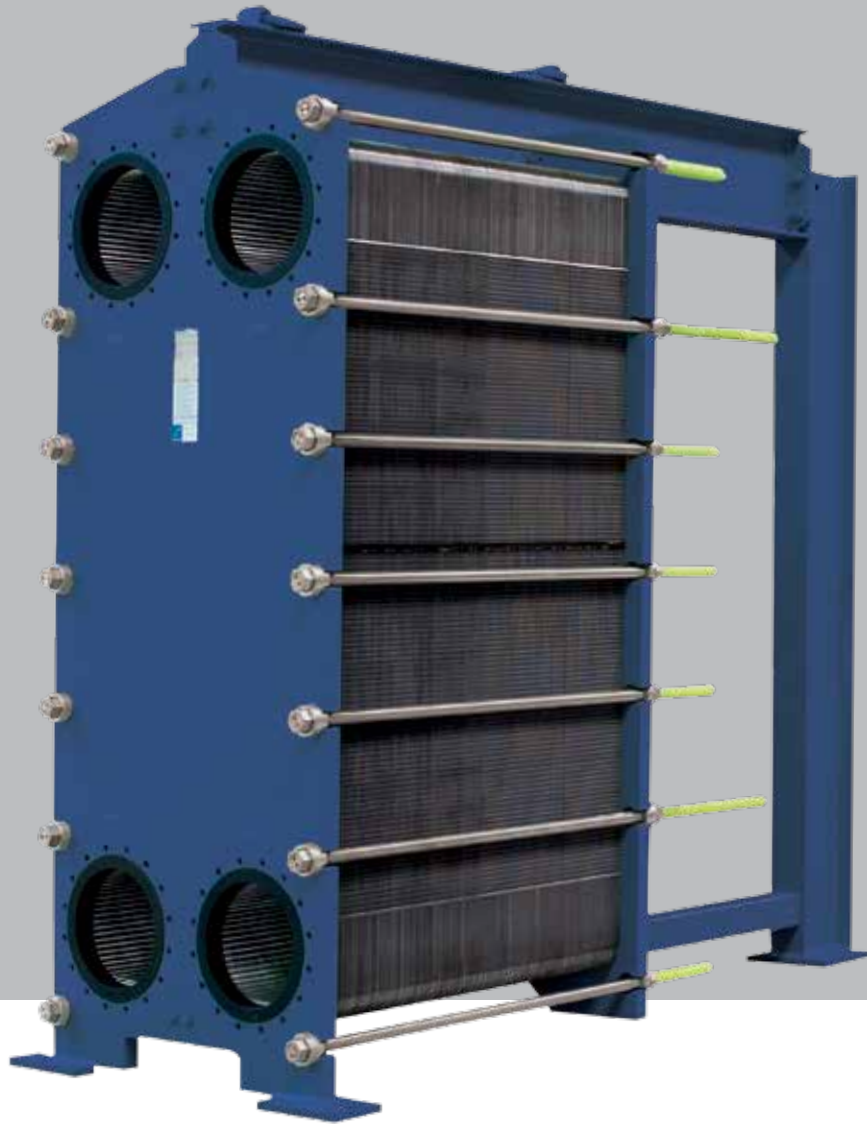

## NT Series

# LEADING TECHNOLOGY FOR ALL APPLICATIONS

The NT Series offers pure application diversity. Thanks to plate types in numerous lengths as well as profile variants, the NT Series is suitable for every requirement. They are decisive in terms of greater performance, more options and less investment. Thanks to the optimised plate design of the NT

Series, you can achieve your targets with fewer heat exchanging surfaces, thus saving investment costs. In combination with a flexible and universal plate range, the NT Series can now be tailor-made to your purposes and their field of application more precisely and with greater flexibility.

### **Their advantages at a glance**

- flexible solutions for special requirements
- OptiWave design – for optimal media distribution
- PosLoc assembly – for a stable plate package
- EcoLoc gasket system – for secure seating of the gaskets



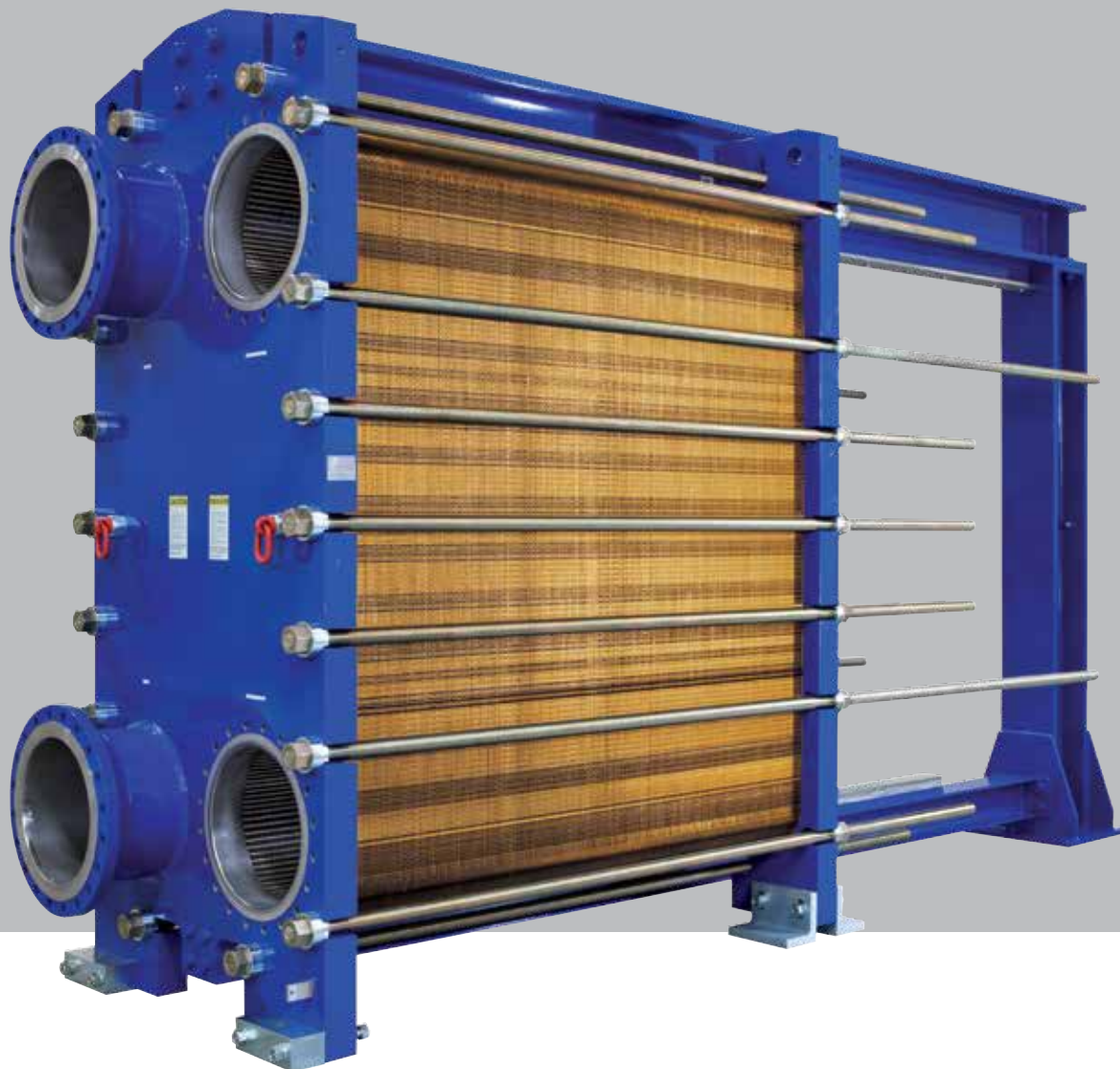

## NH Series

# HIGH PERFORMANCE UNDER HIGH PRESSURE

Wherever high pressure resistance is required by the applications, the newly-developed NH Series proves its extreme load capacity. You also benefit from the greater surface area in terms of high efficiency heat exchange. This is enabled by the combination of special materials and the innovative design, which offers a different corrugation filed when compared to the NT Series. This has significant effects: The high-performance plate heat exchanger withstands operating

pressures of up to 30 bar. Apart from this, the shaping of plate materials such as titanium or special materials such as SMO 254, Alloy 59, Alloy 686 and C-276 is naturally possible. With a plate design that has been adapted to the requirements of oil and gas production, the NH Series provides you with heat exchangers that can best handle pressure.

### Their advantages at a glance

- increased pressure resistance thanks to a new plate design
- PosLoc assembly – for a stable plate package
- OptiWave design – for optimal media distribution
- EcoLoc gasket system – for secure seating of the gaskets

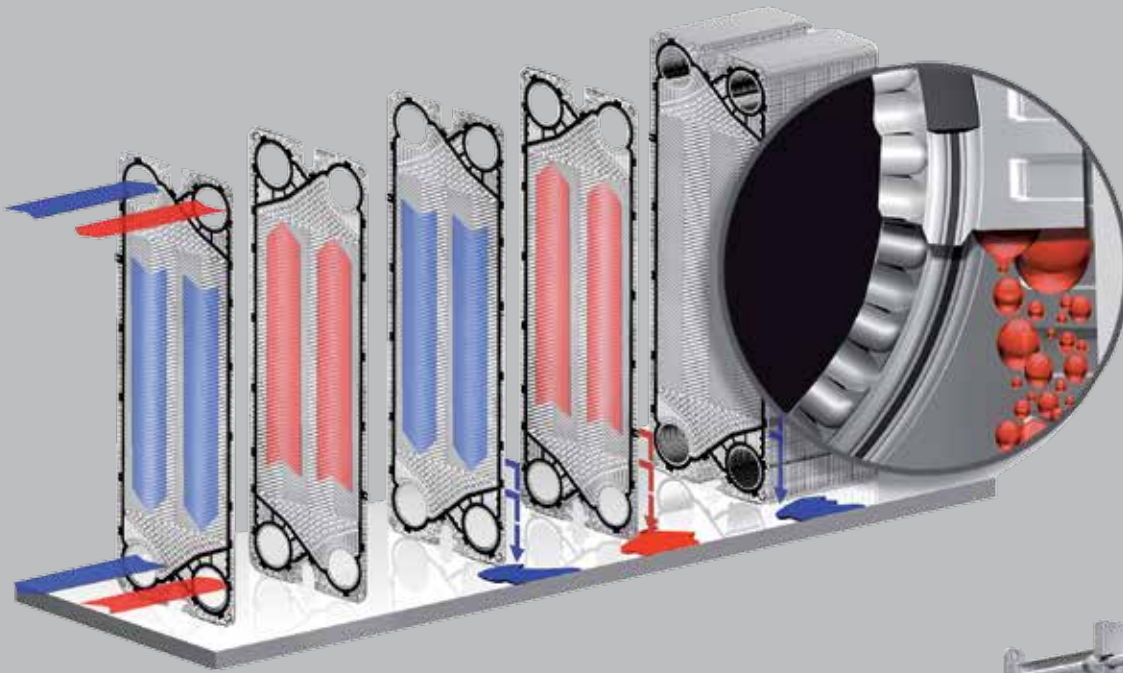

## ND Series

# PLATE DUO PLAYS IT COMPLETELY SAFE

With the ND Series, our experts have conceptualised an extremely reliable variant of the conventional gasketed heat exchanger. Two especially thin plates, the core openings of which are welded, create a narrow leakage gap within a double wall. In the event of the rupture of a plate, this clever solution ensures that the possibility of incompatible media remains excluded and that the rupture is indicated.

The compact design and the functionality of the Safetytherm meets the high standard that is expected of an industry leader such as Kelvion. Our customers can rest assured. The ND Series shines as an effective and low-maintenance double-wall solution, which in the same way as the famous double-bottomed grid assures a high level of production reliability.

### Their advantages at a glance

- high production security with low risk of leakage
- OptiWave design – for optimal media distribution
- EcoLoc gasket system – for secure seating of the gaskets
- PosLoc assembly – for a stable plate package

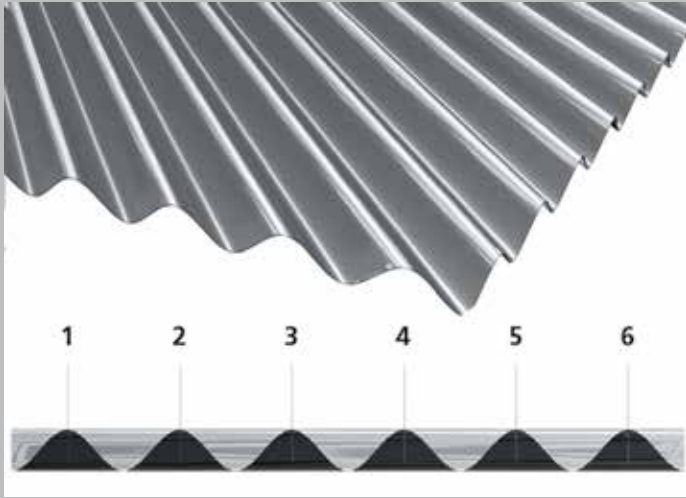

NT Series corrugation

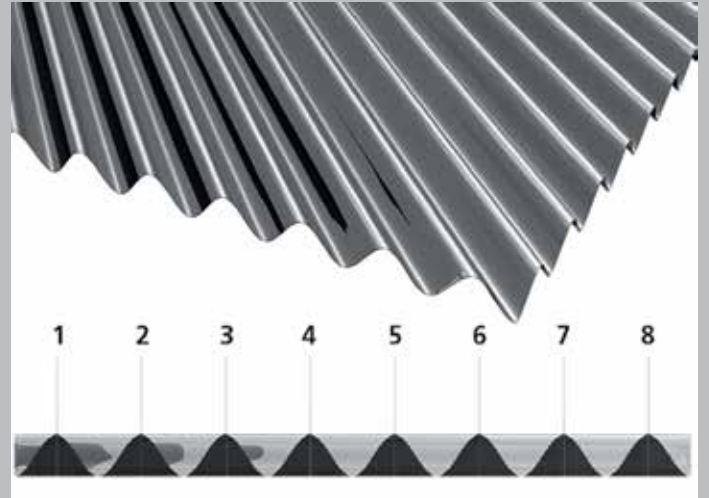

Narrow NX Series corrugation. The narrow corrugation makes the NX pressure resistant and ensures a highly turbulent flow behaviour.



## NX Series

# HIGH PERFORMANCE FOR EFFICIENT REMOTE REFRIGERATION

Our NX plate heat exchangers are based on the successful NT technology. They have been specially developed for high-performance remote refrigeration systems, which require minimal temperature differences and maximum pressure resistance. The NX Series can show their strengths especially in ex-

treme climate zones and in tall buildings as a means of system separation for different operating pressures. Pressure resistance runs up to 30 bar. That corresponds to a water column 300 meters high. The temperature fluctuation lies at a maximum of 1°C and is thus adequate for the most demanding tasks.

### Their advantages at a glance

- highest heat transfer rates
- extremely small temperature differences
- OptiWave design – for optimal media distribution
- PosLoc assembly – for a stable plate package
- EcoLoc gasket system – for secure seating of the gaskets

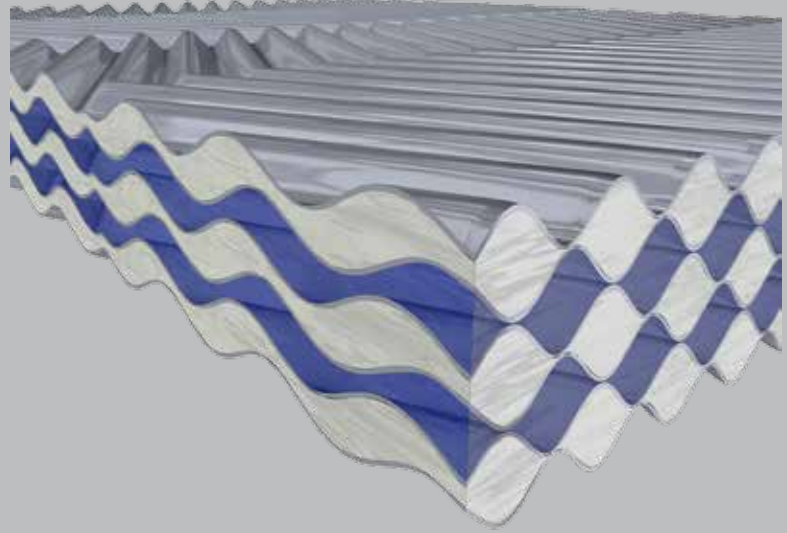

## NL Series

# FOR HIGH VISCOSITY AND THE MOST STRINGENT DEMANDS

The new NL Series has been specially developed for fluids with high viscosity as well as for viscous and shear-sensitive media. This not only offers all the advantages of the NT family, such as PosLoc, EcoLoc and the proven OptiWave design but also a clearly deeper corrugation depth. The result is a particularly gentle and uniform heat treatment of sensitive products such as dairy products, foodstuffs and beverages.

Due to the outstanding interaction of the plate profile and the corrugation depth, the flow properties are improved and blockages are reduced to a minimum. Thanks to the gaskets with foodstuff approval, the NL Series is best suited to applications in the sugar and foodstuff industries. In addition, the field of application ranges from the chemical and paper industries through heavy industry to the oil and gas industry.

### Their advantages at a glance

- Extended service life due to greater corrugation depth, which improves the flow and reduces the tendency to clog up.
- Pressure resistance runs up to 25 bar
- Ideal for fluids with higher viscosity as well as for viscous and shear-sensitive media.
- Suitable for media that contain short fibres or small particles/solids
- Gentle product handling



## NW Series

# FREE FLOW EVEN WHEN IT'S THICK

With the NW Series we have conceptualised a heat exchanger plate that has been specially developed for use with media containing particles and solids. These solids tend to clog plate heat exchangers, thus causing costly downtime, such as can occur in bio-ethanol production, in the pulp and paper industry and in waste-water treatment. The NW Series offers a solution to this problem, as thanks to the deeply corrugated plate gap, blockages are practically impossible.

The herringbone corrugation with metallic support points ensures the required highly turbulent flow that prevents fouling and contributes to the self-cleaning of the plates and in addition increases the heat transfer performance. Taken in combination, this leads to a longer service life of the plate heat exchanger and your maintenance costs are notably reduced.

### **Their advantages at a glance**

- free flow for media containing particles
- longer service life, lower operating costs
- minimal pressure loss, even with viscous media
- turbulence promotes the self-cleaning effect
- high pressure resistance

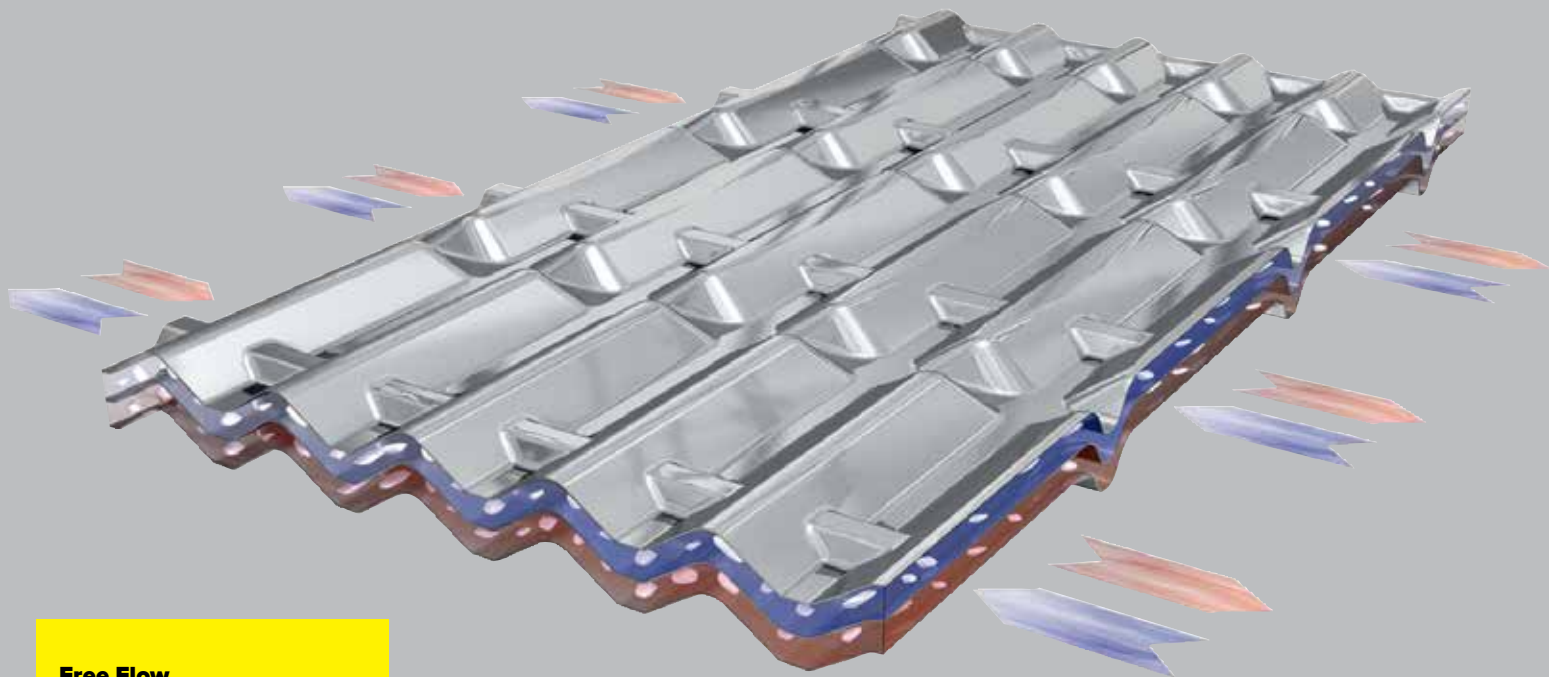

### Free Flow

The constant-width gap ensures blockage-free operation.

## Free Flow Series

# FOR FIBRE- AND SOLID-BEARING MEDIA

Our Free Flow plate heat exchangers are ideally suited to media that contain fibres and solids. With their low investment and operating costs, they are the alternative to shell-and-tube and spiral heat exchangers. Predesigned for use with media containing fibres and solids, the Free Flow series is recommended for use in the sugar and paper industries. Their special feature is focused precisely on use with media containing fibre and

solids, which are beyond the capabilities of conventional plate exchangers. And this is precisely where the field of application of our Free Flow plate heat exchangers begins. Their special feature is the constant-width flow area between the individual plates as well as their coarsely fluted profile. The space between the plates measures up to 12 mm.

### Their advantages at a glance

- blockage-free operation thanks to gap of constant width
- especially suitable for applications involving media containing fibres and solids
- the alternative to shell-and-tube and spiral heat exchangers thanks to smaller investment and operating costs as well as smaller space requirements

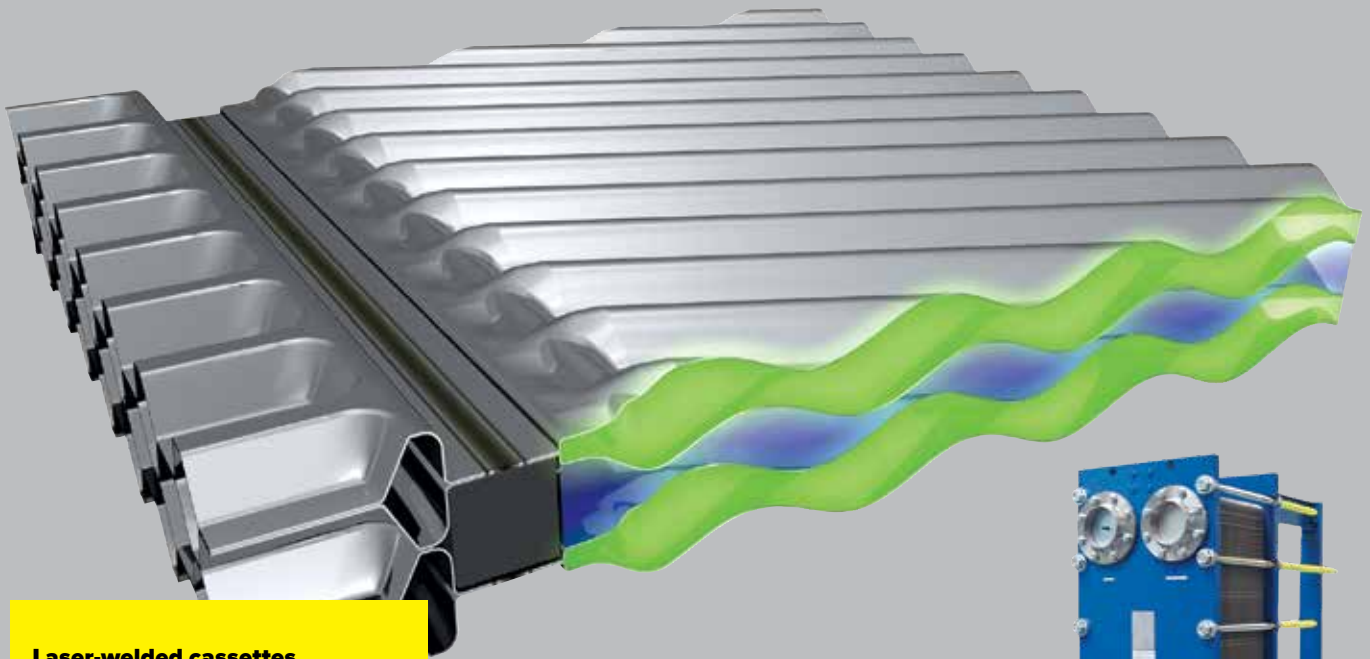

**Laser-welded cassettes**

The precisely manufactured laser weld seam hermetically seals the flow field.



**LWC Series**

**NT PLATE TECHNOLOGY THAT IS ALSO FOR CRITICAL MEDIA**

Conventionally sealed plate heat exchangers soon reach their limits when used with critical media. Kelvion solves this problem with the most modern technology. This is because aggressive media can also flow in the laser-welded cassettes of the LWC plate heat exchangers. Based on the NT plate technology, the LWC Series is manufactured according to the most up-to-date methods of cal-

culatation, design and manufacture. Our LWC plate heat exchangers function according to the principle of flow channels that are 100 % separate from each other. This absolute separation of channels is what makes many industrial applications at all feasible.

**Their advantages at a glance**

- easy assembly, cleaning access from the product-side
- PosLoc assembly – for a stable plate package
- laser-welded cassettes assure the highest process reliability even in the case of aggressive media
- EcoLoc gasket system – for secure seating of the gaskets
- OptiWave design – for optimal media distribution

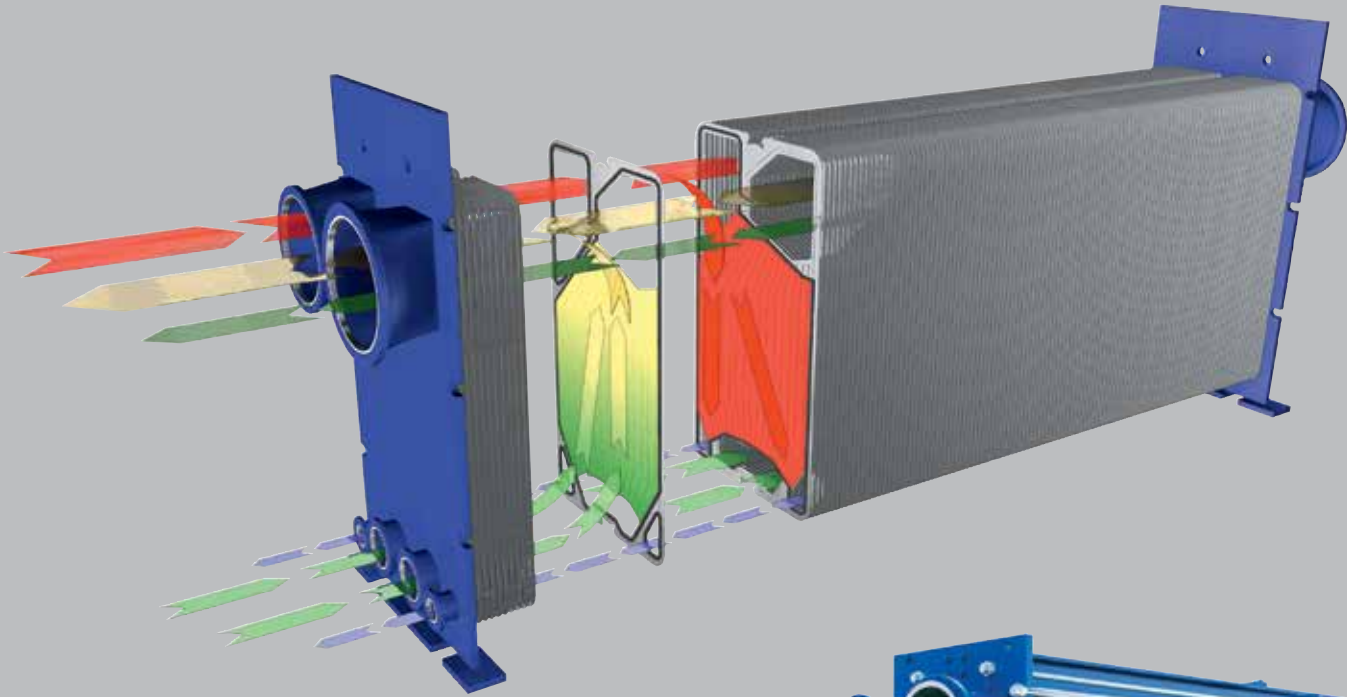

**Treats your products gently**  
Minimal dwell times assure gentle handling of the product.

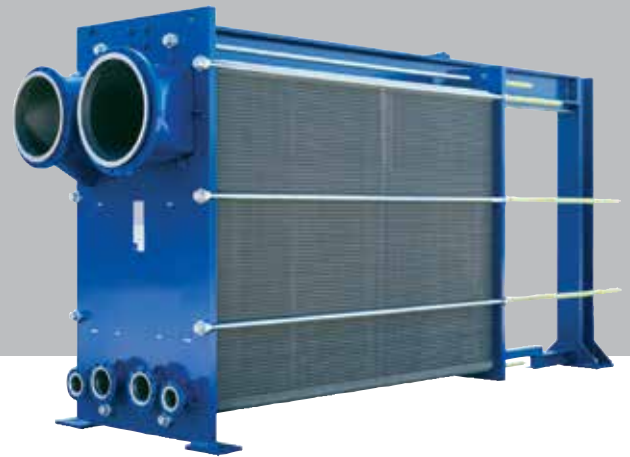

## Concitherm

# PLATE EVAPORATORS WITH HIGH PERFORMANCE

The Concitherm Series provides particularly high performance in rising-film plate evaporators that are often used in the sugar industry. In addition, they are suitable for use as boosters in combination with conventional tube-type evaporators. The optimised plate structure of the Concitherm Series makes it possible to have wide gaps with only a few contact

points over up to 3 m<sup>2</sup> of heat transfer area per cassette. At the same time they offer convincingly greater heat transfer compared to conventional shell-and-tube heat exchangers.

### Their advantages at a glance

- 3 m<sup>2</sup> heat exchanger surfaces per laser-welded cassette enable high evaporator output and a compact design
- no clogging and easy cleaning reduce the production costs



### **A convincing solution**

With its GG Series, Kelvion presents a convincing solution to the details of potable water-heating. They combine the many advantages of our gasketed and brazed plate heat exchangers.

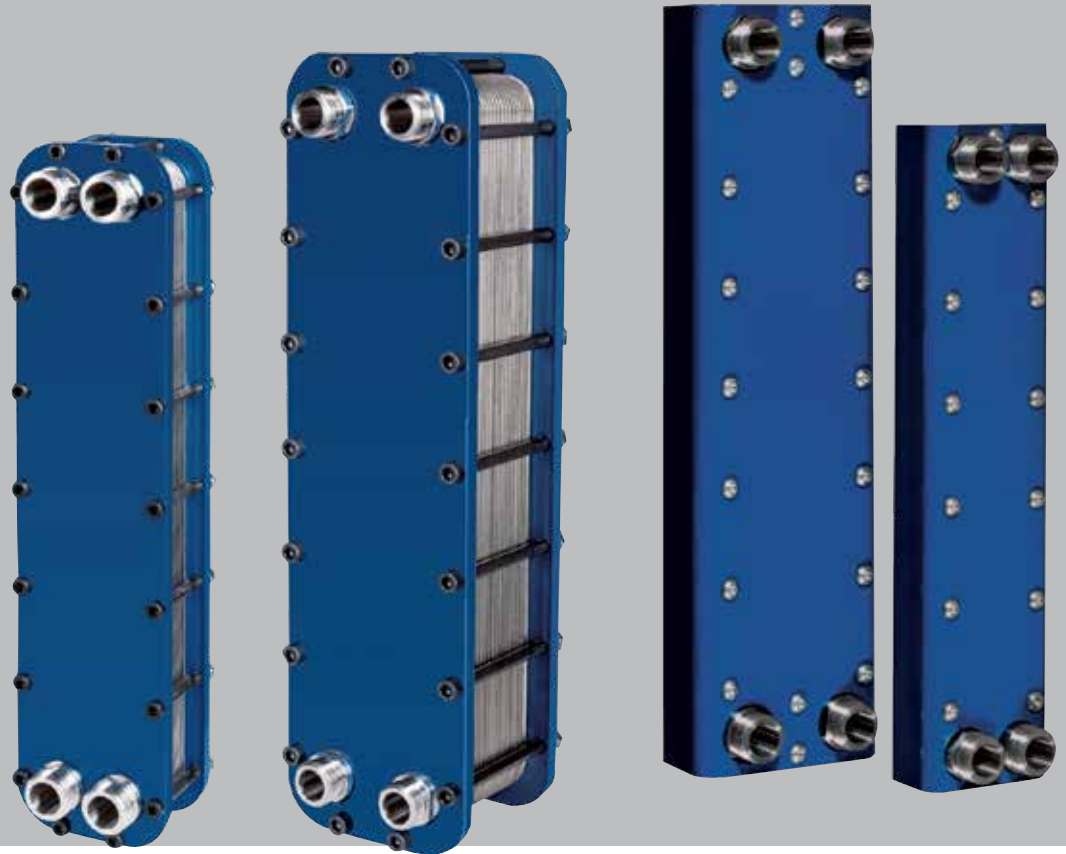

## **GG Series**

# **GASKETED PLATE HEAT EXCHANGERS FOR HEALTHY DRINKING WATER**

Anyone who requires potable water is dependent on extremely efficient and reliable plate heat exchangers for it to be heated. Our plate heat exchangers comply with European and international requirements and function with all the reliability that is to be expected from an industry leader such as Kelvion. We regard strict requirements and statutory regulations to be an incentive. With its GG Series, Kelvion presents a convincing solution to the special requirements of potable water-heating. In the search

for a plate heat exchanger that is free of non-ferrous metals, our experts have found a solution that is as affordable as it is clean. The GG Series combines the many advantages of our gasketed and brazed plate heat exchangers in an elegant manner. A special gasket, combined with stainless steel plates and a made-to-measure frame design form the basis of a cost-effective and food-safe heat exchanger.

### **Their advantages at a glance**

- preferred for potable water applications
- corrosion-proof
- long service life
- FDA-listed gaskets
- smallest installation conditions

EcoBraz

# COMPONENTS FOR HEATING SYSTEMS, HEAT PUMPS AND REFRIGERATION



**A suitable plate heat exchanger series for each production stage:**

	Description	Specifications
<p><b>The GBS Series</b> Copper brazed Strong performers – variable sizes Multiple applications</p>	<p>A brazed all-rounder that can be used for applications up to 31 bar and +200°C</p>	<ul style="list-style-type: none"> <li>Heating/service-water systems</li> <li>Under-floor heating</li> <li>Super cooler and condensers</li> <li>Economizer</li> <li>Refrigerant evaporator</li> <li>Oil coolers and many other industrial applications</li> </ul>
<p><b>The GBH Series</b> Copper brazed Stay cool – even under high pressure</p>	<p>The GBH Series is designed for pressures up to 45 bar and is most suitable for applications with the environmentally-friendly R410A refrigerant</p>	<ul style="list-style-type: none"> <li>Evaporators in air-conditioners</li> <li>Heat pumps for heating and hot water production</li> <li>Process cooling</li> <li>Economizer</li> <li>Super cooler and condensers</li> </ul>
<p><b>The GBE/GKE Series</b> Copper brazed The economical solution at full output</p>	<p>Our “E” stands for Eta: greatest efficiency at lowest costs These efficient plate heat exchangers give you total control: Size, weight, output, quality and economy</p>	<ul style="list-style-type: none"> <li>Modular design</li> <li>Compact and cost-effective</li> <li>ConBraz design availability</li> <li>Heating and service water systems</li> <li>Hydraulic applications</li> </ul>
<p><b>The GWH Series</b> Copper brazed High pressure heat exchanger of the 2nd generation</p>	<p>The GWH Series – the solution for applications with high mechanical and thermal loads Robust, compact heat exchanger for industrial applications with an operating pressure of up to 55 bar.</p>	<ul style="list-style-type: none"> <li>High permanent pressure resistance</li> <li>Small footprint and low weight</li> <li>Cost-effective</li> <li>Robust design</li> <li>Cascade applications</li> <li>Rolling stock and marine applications</li> </ul>



**Tailor-made for the most varied applications**

Kelvion's brazed heat exchangers offer tailor-made solutions for the greatest possible range of applications. Thanks to the automated manufacture and compact design of our EcoBraze Series, we can assemble a customised heat exchanger in the shortest time possible. We choose between copper- and nickel-brazed or VacInox plate heat exchangers depending on the field of application. We look for the most economical solution from the various sizes and diverse accessories available to us and adapt them precisely to your requirements with customised connections.

	Description	Specifications
<p><b>The GKS Series</b> ConBraze – copper brazed New benchmarks in heat transmission</p>	<p>The GKS Series – highest transfer performance by means of a completely new plate geometry using the improved heat transfer of concave/convex vortex cells.</p>	<p>Increased efficiency – greater output</p> <p>Appreciably less refrigerant</p> <p>Plate corrugations adapted to the application</p> <p>Best suited to heating and refrigeration applications</p>
<p><b>The GKH Series</b> ConBraze – copper brazed, highest pressures – highest output</p>	<p>Operating pressures up to 50 bar and new plate geometry create an apparatus that satisfies the highest requirements</p>	<p>Greatest pressure resistance</p> <p>Evaporators, condensers and economisers for high-pressure heat pumps and refrigeration systems</p>
<p><b>The GML Series</b> Copper brazed Conceptualised for the safe use of high-pressure refrigerants</p>	<p>This series is suitable for refrigeration and air-conditioning applications, in which pressures of up to 75 bar must be maintained.</p>	<p>Has a very high pressure resistance</p> <p>Compact and space-saving</p> <p>CO<sup>2</sup> stands out as a carbon-neutral refrigerant</p> <p>This forward-looking system is an economical and advantageous solution</p>
<p><b>The DW Series</b> Copper brazed Double-walled safety plate heat exchanger</p>	<p>DW stands for “Double Wall” and assures the greatest safety due to its double-walled, hermetically-sealed heat exchanger plates at pressures up to 45 bar</p>	<p>Double-walled safety construction</p> <p>Reliable separation of the media</p> <p>New plate design</p> <p>More pressure resistant and efficient</p> <p>Conceptualised for heat pumps and domestic connection stations</p>

EcoBraz

# COMPACT, COST-EFFECTIVE – FOR SYSTEM PRESSURES UP TO 140 BAR



	Description	Specifications
<b>The GBH-HP Series</b> Copper brazed Highest-pressure heat exchanger with pressure frame	A brazed plate heat exchanger with pressure frame for transcritical and subcritical CO <sup>2</sup> applications and industrial fields of application with system pressures up to 140 bar.	Cost-effective and durable with the greatest resistance to pressure Industrial heating and cooling CO <sup>2</sup> heat pumps and supermarket refrigeration plants Power station technology
<b>The GVH-HP Series</b> VacInox solder For the highest operating pressures	Free of non-ferrous metals brazed plate heat exchanger for industrial applications with an operating pressure of up to 46 bar combining the advantages of brazed and gasketed heat exchangers.	High thermal efficiency High operating pressure Connection geometry of DN15 up to DN100 Compact design and minimal space requirements Ammonia refrigeration plants and cascades
<b>The TD Series</b> Copper brazed 3-media heat exchanger	True-Dual dual-circuit evaporator represents constant high efficiency. A brazed heat exchanger combining two refrigerating circuits with a water or solar circuit.	Diagonal flow principle for optimal utilisation of the transfer surface TD ensures that this optimum is achieved even when operating at partial load Interlaced channel configuration Both refrigerating circuits in 100% contact with the water/solar circuit Designed for refrigeration plants and heat pump systems



**Vaclnox**  
 a specially-developed plate heat exchanger that is free of non-ferrous metals and suitable for pressures up to 35 bar.

	Description	Specifications
<p><b>The GVH Series</b>            Non-ferrous metal free stainless steel plate heat exchangers            Vaclnox – new technology</p>	<p>Our new, unique and revolutionary technology for bonding stainless steel plates enables both a compact design and the greatest corrosion resistance. Vaclnox stainless steel plate heat exchangers are thus the answer for the most stringent requirements in potable water supply and in critical industrial applications up to 35 bar.</p>	<p>Can also be used under extreme conditions and with highly corrosive media</p> <p>Combines the advantages of brazed heat exchangers and great resistance to corrosion and pressure</p> <p>Evaporators and condensers for ammonia systems</p> <p>Laser cooling</p> <p>Potable water heating</p>
<p><b>The GNS Series</b>            Nickel-based solder            Highly corrosion-resistant</p>	<p>Copper-free brazed plate heat exchangers offer all advantages of a brazed plate heat exchanger, yet thanks to the special solder are significantly more resistant to corrosive media.</p>	<p>Compact and cost-effective</p> <p>For use with desalinated water and corrosive fluids.</p> <p>Laser cooling</p> <p>Economizer</p> <p>Ammonia systems</p>
<p><b>The XCR Series</b>            Nickel or copper brazed            Suitable for pool technology applications</p>	<p>The XCR Series uses stainless steel plates of 1.4547 (SMO 254) and are resistant to chloride content, as is usually found in pool technology.</p>	<p>Long service life due to high-quality stainless steel</p> <p>Corrosion-proof in the face of high chloride content.</p> <p>Upon request, individual testing of the chloride/temperature relationship can be performed</p>

K°Bloc

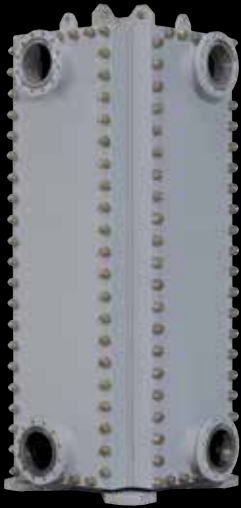

K°Flex

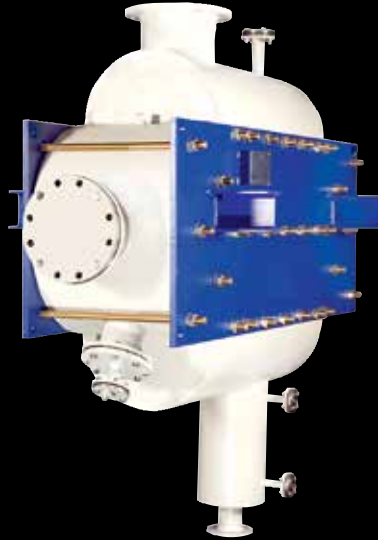

REKULUVO



Our fully-welded plate heat exchangers make a convincing case due to their minimal size, outstanding thermal transmission coefficients and comparatively minimal investment costs. They are particularly robust and require only minimal cleaning and servicing. The design advantages thus come into play in areas in which in addition to the output, load capacity is also required. In addition, each series has its specific advantages and areas of application. The conclusion: Developed for the challenges of specific applications, the EcoWeld product line offers convincing performance even under the most difficult circumstances.

## Fully welded plate heat exchangers

# FOCUSED ON THE MOST STRINGENT REQUIREMENTS

### Overview of the fully welded plate heat exchangers

	K°Bloc	K°Flex	REKULUVO/ REKUGAVO
<b>Maximum temperature</b>	350 °C	900 °C	700 °C
<b>Maximum pressure</b>	35 bar	60 bar	1,4 bar (max. 0,4 Diff.)
<b>Area</b>	1-860 m <sup>2</sup>	1-12.000 m <sup>2</sup>	500-250.000 m <sup>2</sup>
<b>Maximum volume flow</b>	10.000 m <sup>3</sup> /h	15.000 m <sup>3</sup> /h	variable

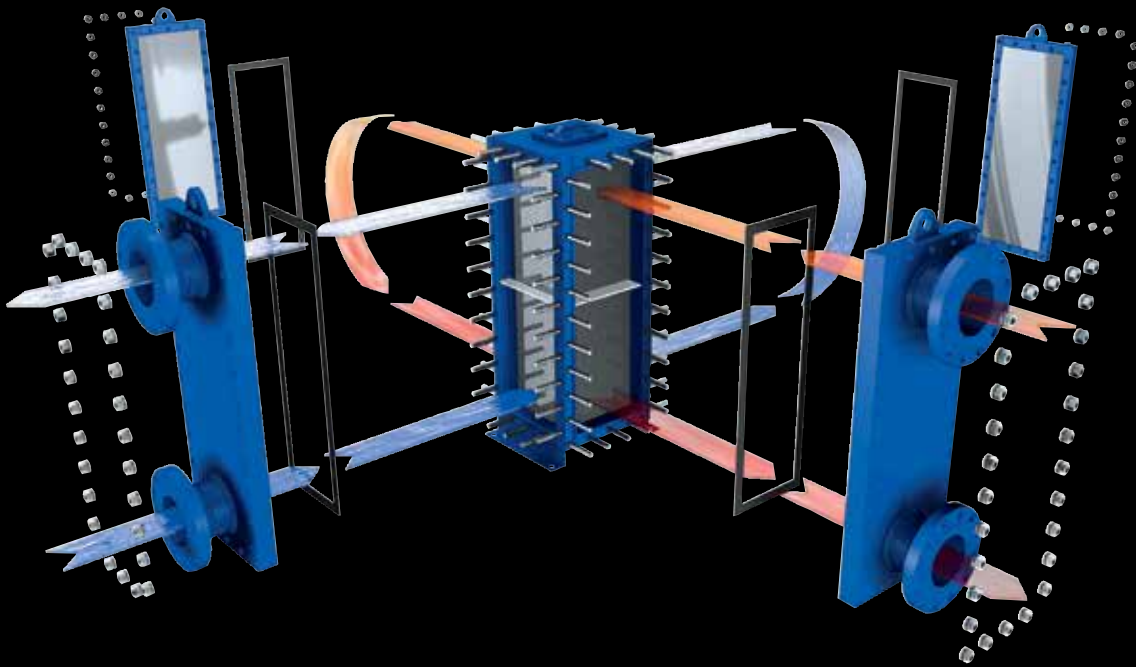

#### Two different plate corrugations

The compact, fully-welded heat exchanger can be equipped with two different plate corrugations, as required by their application. The chevron corrugation assures highly efficient heat transfer, the double-dimple corrugation is most suited to demanding media with high viscosity or for vacuum condensation.

## K°Bloc

# FULLY WELDED FOR OIL AND GAS AS WELL AS PETROCHEMICALS

The K°Bloc is a fully-welded plate heat exchanger that is used above all in the oil and gas industry, the chemical industry as well as in the petrochemical sector. The solidly bolted frame consists of four columns, top and bottom plates as well as four side plates. These can be detached swiftly and allow

free access all the way around for the thorough and easy cleaning of the fully-welded plate packages. Two different plate corrugations are available. Chevron corrugation enables effective heat transfer. In contrast, dimple corrugation is the first choice for highly viscous media.

#### Their advantages at a glance

- Fully welded plate heat exchanger package
- for applications at temperatures up to 350 °C and pressures up to 35 bar
- small footprint and low installation cost
- Access to both sides of the media
- easy cleaning thanks to unproblematic opening of the apparatus

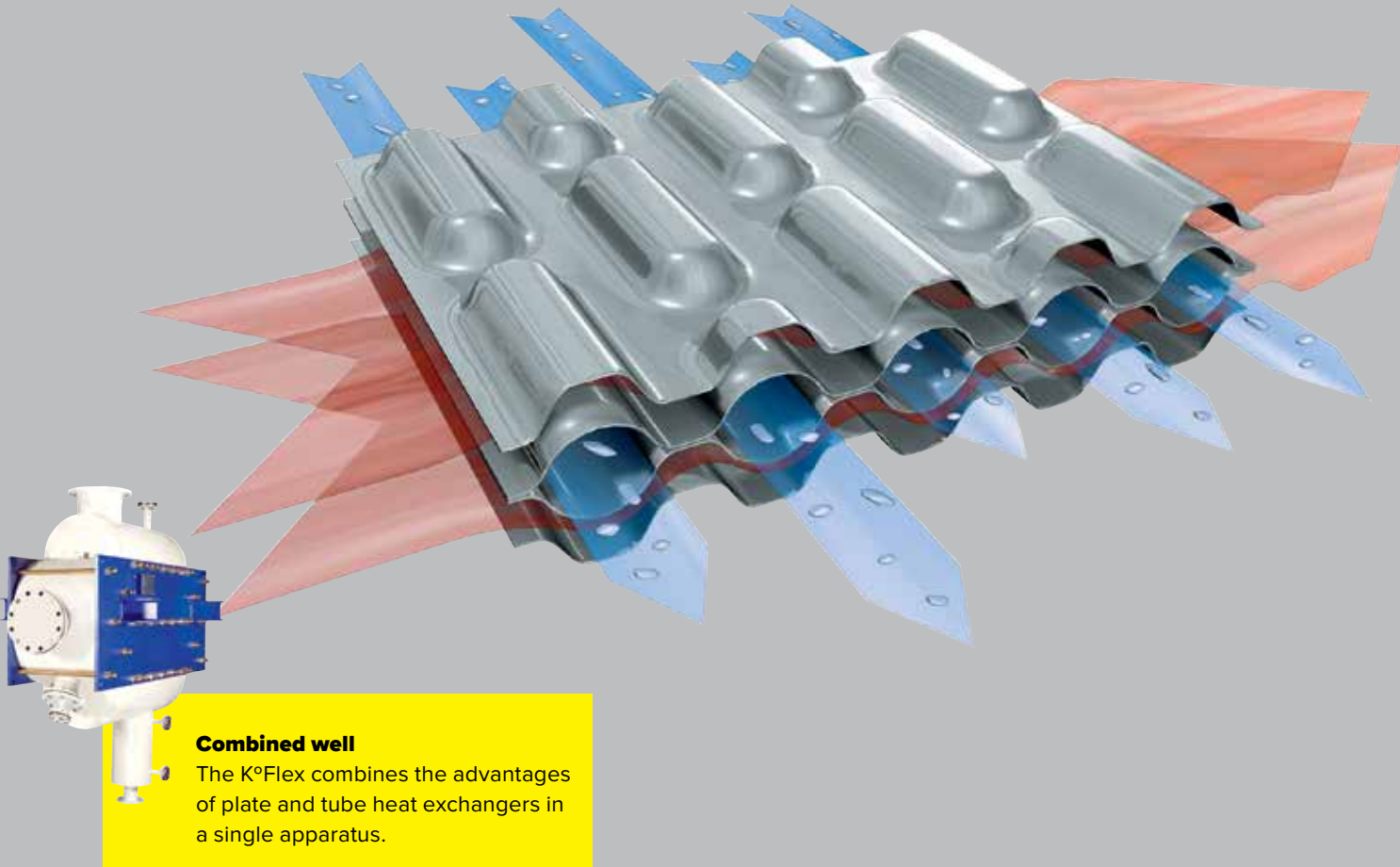

#### Combined well

The K°Flex combines the advantages of plate and tube heat exchangers in a single apparatus.

## K°Flex

# FULLY WELDED FOR MULTIPLE APPLICATIONS

The K°Flex combines the advantages of shell-and-tube and plate heat exchangers in a single apparatus. This makes it predestined for the most varied applications: e.g. as a condenser in the power station sector, as a plate-type falling-film evaporator in the sugar industry, as a condenser, evaporator and heat exchanger for the thermal treatment of 2-phase mixtures in the chemical and petrochemical industries as well as in the oil and gas industry.

Thanks to its customisable design it is equally successful when used as a head condenser. The plate structure enables a high output density. Efficient, turbulent heat transfer is already possible at minimal temperature differentials and varying volume flows. Even in the case of a large volume flow, the loss of pressure at the tube is minimal. In comparison with previous solutions, the effort involved in cleaning is clearly reduced.

#### Their advantages at a glance

- media containing fibres and solids can be used at the tube-side with a large, open flow area
- high condensation outputs up to 200 MW and condensate supercooling in a single apparatus
- operation in a vacuum with minimal pressure losses
- variable temperature limits up to 900 °C
- variable pressure limits up to 60 bar as well as high pressure differentials between media



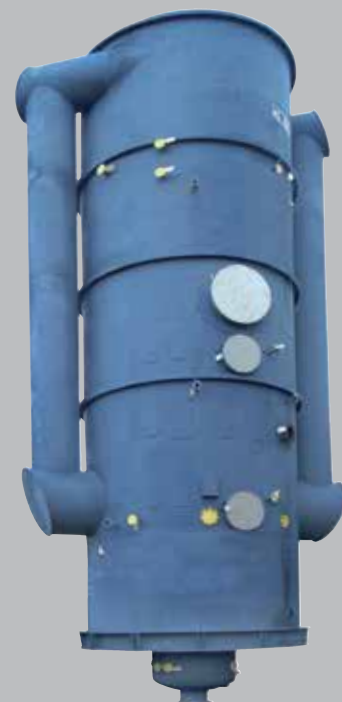
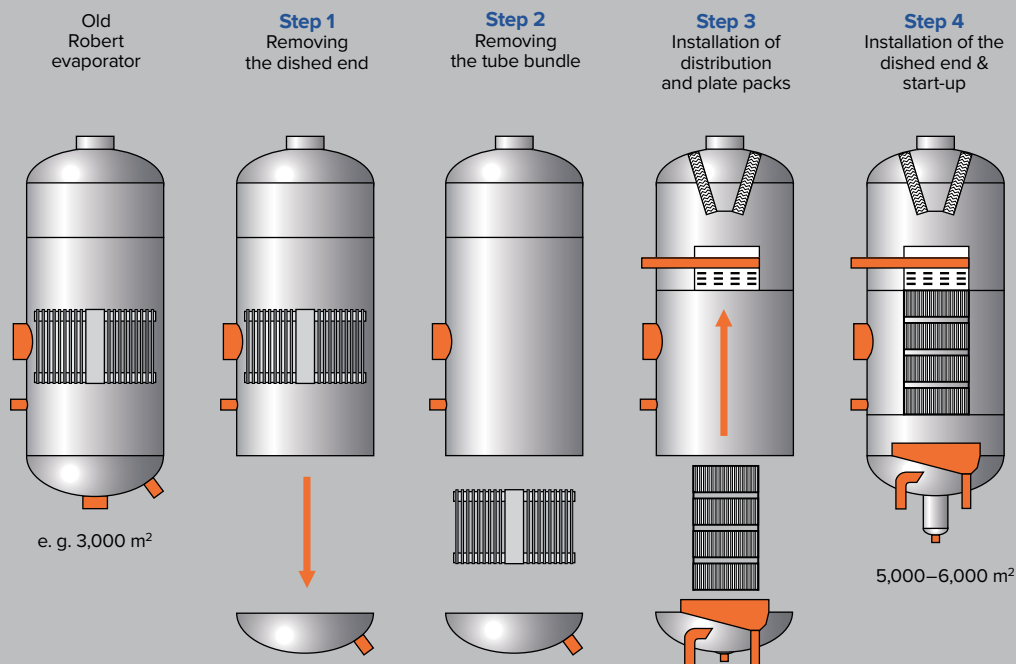

### A gentle high-performance evaporator

Outstanding thermodynamic characteristics enable energy-saving designs. The design aimed at efficiency simultaneously assures gentle handling of the sugar syrup by means of low temperature differentials and short dwell times.

## EvapPlus

# AS EVAPORATOR IN THE SUGAR- INDUSTRY

As gentle product handling and energy saving are at the forefront in sugar production, the EVAPplus plate-type falling film evaporator is precisely the right solution. The most modern technology ensures the highly efficient concentration of sugar beet and sugar cane syrup. The advantages of the EVAPplus can also be applied to the subsequent output increase of existing Robert

evaporators. Alterations to buildings, foundations or to the statics of the plant are usually not required in doing so. The heating coil is simply removed from the Robert evaporator and replaced with a EVAPplus plate package with a manifold. The heating surface and the efficiency of the system is thus considerably improved with minimal cost.

### Their advantages at a glance

- highest heat transfer rates
- minimal temperature differentials
- short dwell time of the syrup in the apparatus
- high heating surface density
- minimal syrup discolouration

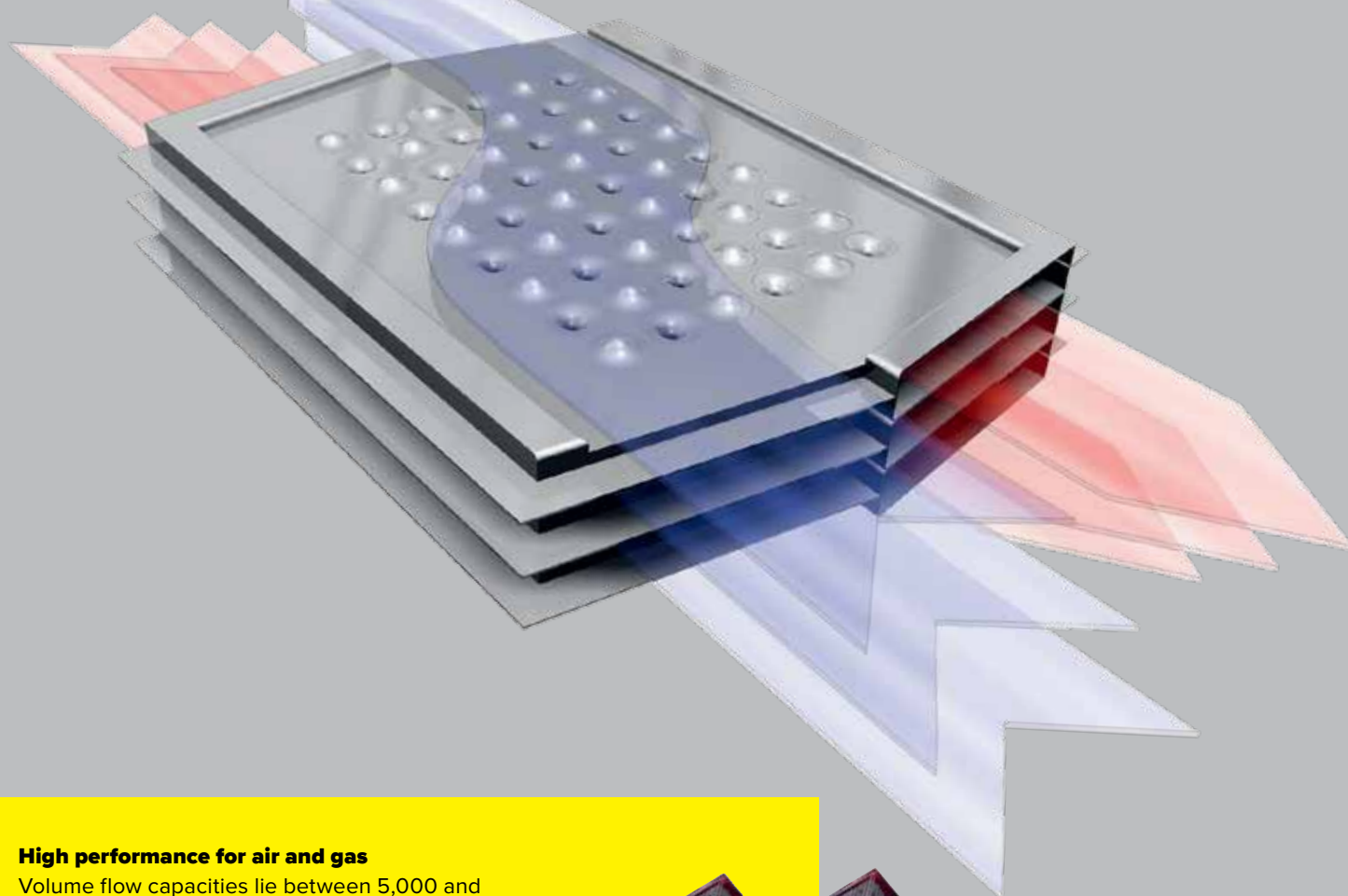

#### High performance for air and gas

Volume flow capacities lie between 5,000 and 2,000,000 Nm<sup>3</sup>/hr. In these quantities, air and flue gas are raised to a temperature of 700 °C without any trouble. In doing so, a recovery rate of up to 97 % is achieved.

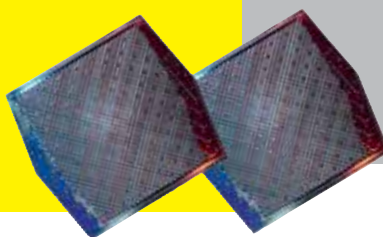

**REKULUVO®/REKUGAVO®**

# FULLY WELDED – HIGH PERFORMANCE FOR AIR AND GAS

Our REKULUVO/REKUGAVO exhaust gas heat exchangers have been specially developed for applications with gaseous media containing pollutants. They are used in thermal power stations, ammonia and methanol factories as well as in environmental technology. Wherever especially high-performance exhaust air or exhaust gas heat

exchangers are required, our REKULUVO/REKUGAVO can be used; for example to preheat sucked-in combustion air or to heat flue gases to the reaction temperature of a catalyst. By means of the counterflow principle, the REKULUVO/REKUGAVO achieves an exceptionally high efficiency of up to 97 %.

#### Their advantages at a glance

- Can be used for noxious media, such as sulphur, chlorine and fluoride
- Recovery efficiency of up to 97 %
- Flow rate of between 5,000 and approx. 2,000,000 Nm<sup>3</sup>/h
- Suitable for temperatures of up to 700 °C
- Can handle pressure differences of up to around 400 mbars

# GASKETED PLATE HEAT EXCHANGERS

Model	Connection size	Dimensions	
	(in mm)	Height (in mm)	Width (in mm)
<b>NT Series 25M ... 150L</b>			
NT 25M	25	570	180
NT 50T	50	670	323
NT 50M	50	930	323
NT 50X	50	1,390	323
NT 80M	80	1,271	435
NT 100T	100	1,110	540
NT 100M	100	1,516	540
NT 100X	100	1,952	540
NT 150S	150	1,717	640
NT 150L	150	2,197	640
<b>NT Series 250S ... 500X</b>			
NT 250S	250	2,272	895
NT 250M	250	2,569	895
NT 250L	250	2,866	895
NT 350T	350	2,553	1,135
NT 350S	350	2,776	1,135
NT 350M	350	3,113	1,135
NT 350L	350	3,450	1,135
NT 500T	500	3,257	1,415
NT 500M	500	3,868	1,415
NT 500X	500	4,479	1,415
<b>NX Series 100X ... 250L</b>			
NX 25M	25	570	180
NX 100X	100	1,952	540
NX 150X	150	2,377	640
NX 250L	250	2,866	895
<b>NH Serie</b>			
NH 250S	250	2,272	895
NH 250M	250	2,569	895
NH 250L	250	2,866	895
NH 350S	350	2,776	1,135
NH 350M	350	3,113	1,135
NH 350L	350	3,450	1,135
<b>ND Safetytherm</b>			
ND 50M	50	930	323
ND 50X	50	1,390	323
ND 100T	100	1,110	540
ND 100M	100	1,516	540
ND 100X	100	1,952	540
ND 150S	150	1,717	640
ND 150L	150	2,197	640

# GASKETED PLATE HEAT EXCHANGERS

Model	Connections		Dimensions	
	(in mm)		Height (in mm)	Width (in mm)
<b>NL Series</b>				
NL 80M	80		1,271	435
<b>LWC Series 100T ... 350S</b>				
LWC 100T	100		1,110	540
LWC 100M	100		1,516	540
LWC 100X	100		1,952	540
LWC 150S	150		1,717	640
LWC 150L	150		2,197	640
LWC 250S	250		2,272	895
LWC 250L	250		2,866	895
LWC 350S	350		2,776	1,135
<b>Free Flow/Wide Gap</b>				
N 40	100-125		1,570	710
FA 184	200		2,015	910
FA 192	350		2,765	1,370
NF/NW350	350		3,450	1,380
<b>Concitherm</b>				
CT 187	max. 350		2,870	1,000
CT 193	max. 600		2,698	1,650
<b>GG Series</b>				
GG 240H	25		464	100
GG 500H	32		535	140

# BRAZED PLATE HEAT EXCHANGERS

Model	Operating pressure up to		Dimensions	
	(in bar)		Height (in mm)	Width (in mm)
<b>GBE Series</b>				
GBE100	16		204	74
GBE200	16		231	90
GBE220	16		328	90
GBE240	16		464	91
GBE400	16		335	124
GBE500	25		532	124
<b>GBS Series</b>				
GBS100	31		204	74
GBS200	31		231	90
GBS220	31		328	90
GBS240	31		464	91

# BRAZED PLATE HEAT EXCHANGERS

Model	Operating pressure up to	Dimensions	
	(in bar)	Height (in mm)	Width (in mm)
<b>GBS Series</b>			
<b>GBS300</b>	31	173	124
<b>GBS400/GBS400-AE</b>	31	335	124
<b>GBS418</b>	40	282	127
<b>GBS420</b>	31	282	127
<b>GBS500/GBS500-AE</b>	31	532	124
<b>GBS525</b>	36	525	118
<b>GBS700/GBS700-AE</b>	31	532	271
<b>GBS757</b>	35	543	281
<b>GBS760</b>	27	519	257
<b>GBS800/GBS800-AE</b>	31	532	271
<b>GBS900/GBS900-AE</b>	31	802	271
<b>GBS910</b>	36	783	318
<b>GBS1000/GBS1000-AE/BE</b>	31	875	386
<b>GBH Series</b>			
<b>GBH100</b>	45	204	74
<b>GBH200</b>	45	231	90
<b>GBH220</b>	45	328	90
<b>GBH240</b>	45	464	91
<b>GBH300</b>	45	173	124
<b>GBH400/GBH400-AE</b>	45	335	124
<b>GBH500/GBH500-AE</b>	45	532	124
<b>GBH700/GBH700-AE</b>	45	532	271
<b>GBH800/GBH800-AE</b>	45	532	271
<b>GBH900/GBH900-AE</b>	45	802	271
<b>GBH1000/GBH1000-AE/BE</b>	45	875	386
<b>GWH Series</b>			
<b>GWH220</b>	55	328	90
<b>GWH240</b>	55	464	91
<b>GWH500/GWH500-AE</b>	55	532	124
<b>GWH700/GWH700-AE</b>	55	532	271
<b>GWH900/GWH900-AE</b>	55	802	271
<b>GML Series</b>			
<b>GML400</b>	70	335	124
<b>GML500</b>	70	532	124
<b>GBH-HP Series</b>			
<b>GBH-HP400</b>	140	410	195
<b>GBH-HP500/GBH-HP500-AE</b>	140	600	195
<b>GBH-HP700/GBH-HP700-AE</b>	140	621	340
<b>GBH-HP1000/GBH-HP1000-AE</b>	130	1050	500

# BRAZED PLATE HEAT EXCHANGERS

Model	Operating pressure up to	Dimensions	
	(in bar)	Height (in mm)	Width (in mm)
<b>GKE Series</b>			
GKE108	16	204	74
GKE228	16	328	90
GKE550	30	532	124
<b>GKS Series</b>			
GKS108	31	204	74
GKS228	31	328	90
GKS550/GKS550-AE	40	532	124
GKS770/GKS770-AE	31	539	278
<b>GKH Series</b>			
GKH108	45	204	74
GKH228	45	328	90
GKH550/GKH550-AE	50	532	124
GKH770/GKH770-AE	45	539	278
<b>GNS Series</b>			
GNS100	16	204	74
GNS200	16	231	90
GNS220	16	328	90
GNS240	16	464	90
GNS300	16	173	124
GNS400/GNS400-AE	16	335	124
GNS500/GNS500-AE	16	532	124
GNS700/GNS700-AE	16	532	271
GNS800/GNS800-AE	16	532	271
<b>GVH Series</b>			
GVH100	35	204	74
GVH108	25	204	74
GVH200	25	231	90
GVH220	25	328	90
GVH228	25	328	90
GVH240	25	464	90
GVH300	25	173	124
GVH400/GVH400-AE	25	335	124
GVH500/GVH500-AE	25	532	124
GVH700/GVH700-AE	27	532	271
GVH800/GVH800-AE	25	532	271
GVH1000/GVH1000-AE/BE	20	875	386
<b>GVH-HP Series</b>			
GVH-HP500/ GVH-HP500-AE	46	600	195
GVH-HP700/ GVH-HP700-AE	46	621	340
GVH-HP1000	46	1,050	500

# BRAZED PLATE HEAT EXCHANGERS

Model	Operating pressure up to	Dimensions	
	(in bar)	Height (in mm)	Width (in mm)
<b>XCR Series</b>			
<b>GBS/GNS220-XCR</b>	31 (GBS) / 16 (GNS)	328	90
<b>GBS/GNS240-XCR</b>	31 (GBS) / 16 (GNS)	464	91 (GBS) / 90 (GNS)
<b>GBS/GNS400-XCR</b>	31 (GBS) / 16 (GNS)	335	124
<b>WP5/GNS500-XCR</b>	31 (WP) / 16 (GNS)	532	124
<b>WP7/GNS700-XCR</b>	31 (WP) / 11 (GNS)	532	271
<b>DW Series</b>			
<b>GBS/GBH400-DW</b>	16 (GBS) / 45 (GBH)	335	124
<b>GBS/GBH500-DW</b>	16 (GBS) / 45 (GBH)	532	124
<b>GBH-HP-DW400</b>	120	410	195
<b>GBH-HP-DW500</b>	140	600	195
<b>TD Series</b>			
<b>TD7/TD7-AE</b>	30	532	271
<b>TD9/TD9-AE</b>	25	802	271
<b>GKS770-TD/GKS770-TD-AE</b>	31	539	278
<b>GKH770-TD/GKH770-TD-AE</b>	45	539	278
<b>GGE/GGS Series</b>			
<b>GGE/GGS240</b>	11 (GGE) / 16 (GGS)	465	100
<b>GGE/GGS500</b>	11 (GGE) / 16 (GGS)	535	140
<b>GGE-DG/GGS-DG Series</b>			
<b>GGE-DG/GGS-DG240</b>	10 (GGE) / 16 (GGS)	482.5	110.3
<b>GGE-DG/GGS-DG500</b>	10 (GGE) / 16 (GGS)	560	152

# FULLY WELDED PLATE HEAT EXCHANGERS

Model	Connection size	Dimensions	
	(in mm, max.)	Height (in mm, max.)	Length = Width (in mm, max.)
<b>K°Bloc</b>			
<b>BT20</b>	150	798	318
<b>BT30</b>	250	1,439	397
<b>BT40</b>	300	1,764	507
<b>BT50</b>	350	2,116	615
<b>BT75</b>	600	3,319	914
<b>BT120</b>	900	3,681	1,500

## K°Flex

Indications of size cannot be given at this point, as the process requirements as well as the outputs influence the dimensions of the plate heat exchangers. Please contact us

## REKULUVO®/REKUGAVO®

Indications of size cannot be given at this point, as the process requirements as well as the outputs influence the dimensions of the plate heat exchangers. Please contact us



**Our service is at your doorstep.**

First and foremost, service makes a good product and a satisfied customer. At Kelvion, we make use of a close-knit service network with trained technicians – worldwide! You receive everything from a single source – inspection, repair, exchange, etc. – promptly, punctually and technically sound, including products or subcomponents from other suppliers. Only high-quality original parts are used. This guarantees secure seating, efficient operation and a long service life.



# AFTER-SALES & SERVICE

# AVAILABLE WORLDWIDE AND 24 HOURS A DAY

Kelvion is the leading service specialist for plate heat exchangers of all types and manufacturers / brands. The spectrum includes all after-sales and service from assembly through maintenance and spare part supply to preventative measures such as the innovative gasket test. The global network of locations enables service 24/7. In so doing, we support you everywhere and at all times to obtain the maximum availability of your systems.

This includes the assembly of the apparatus. The fully-assembled approach has a decisive effect on problem-free functioning. Kelvion is also available to assemble the plate heat exchangers in the event that the system is delivered in a disassembled state. Preventative maintenance is a further service. Plate heat exchangers can become dirty or worn. We offer a visual check

as preventative maintenance and inform you regarding the cleaning or servicing required and the expected costs. Minor contamination can also be removed immediately on site. The safe alternative is, however, mechanical or chemical treatment of the plates in Kelvion's special workshops.

Our main aim is to ensure the long-term availability of the apparatus. High-quality and absolutely tailored spare parts are essential for the trouble-free operation of your plate heat exchanger. In addition to original parts, we also offer certified products of other quality suppliers, whose attractive price-to-performance ratio is particularly valued by our clients. Plates and gaskets for practically all brands and types are kept in stock continuously, or are supplied at short notice.

## The five basic reasons that make us leading specialists:

- **Quality and safety:** Highest quality service is the result of individual customer service and precise work.
- **Innovation:** Flexibility creates solutions for the various specifications of our clients.
- **Efficiency:** Optimised operational processes and maximal availability of systems assures greater efficiency.
- **Expertise:** Diverse knowledge and experience lead to pooled competencies – thus offering our customers decisive advantages.
- **Trustworthiness:** Reliability, a sense of responsibility and transparency when communicating with the client distinguish the manner in which our service personnel work..

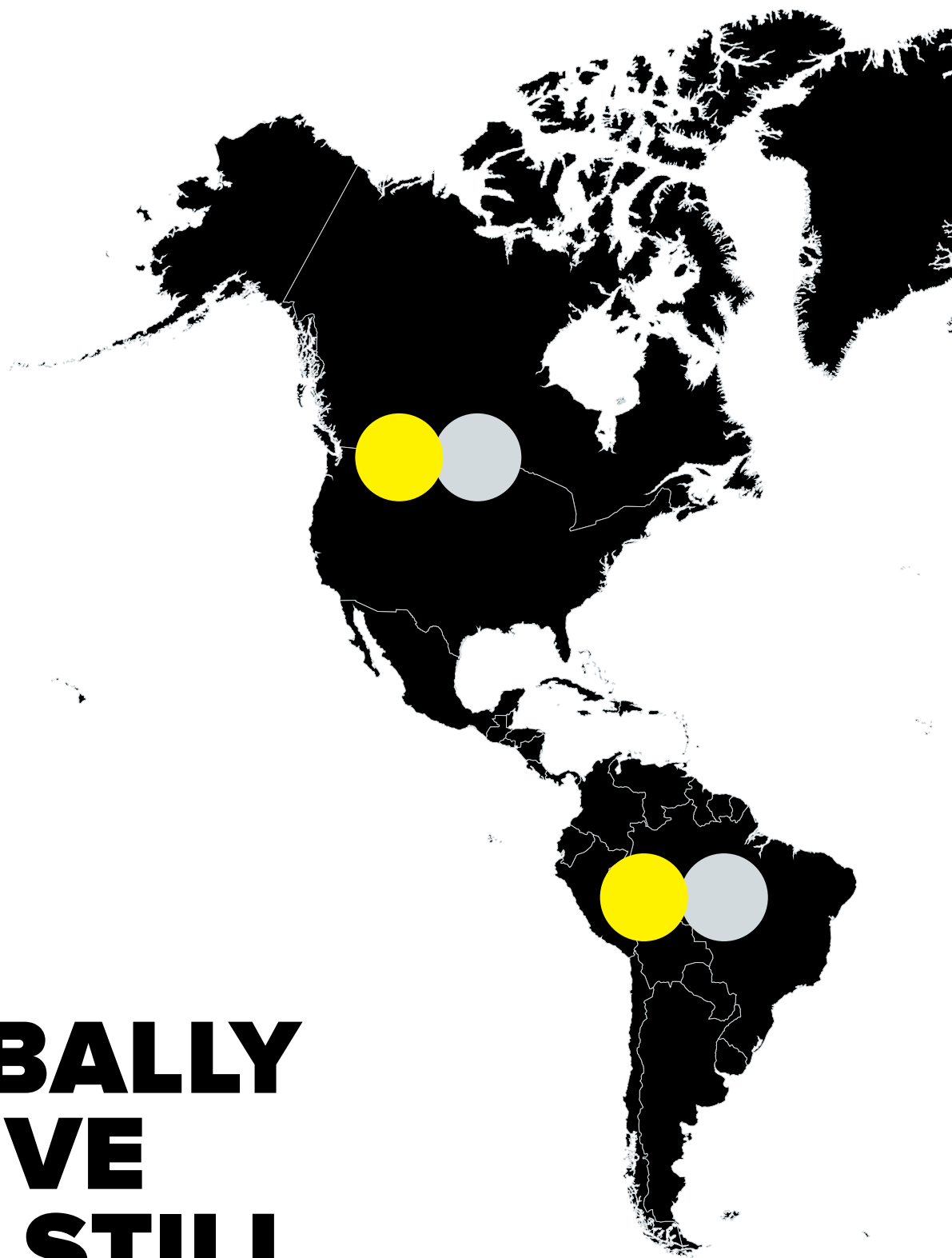

# **GLOBALLY ACTIVE AND STILL CLOSE BY**

No matter where your market is, regardless of country, we are never far away. We are always happy to answer any questions you may have and meet your requirements. Even the largest, most successful project begins with an initial, profitable conversation. We look forward to hearing from you.

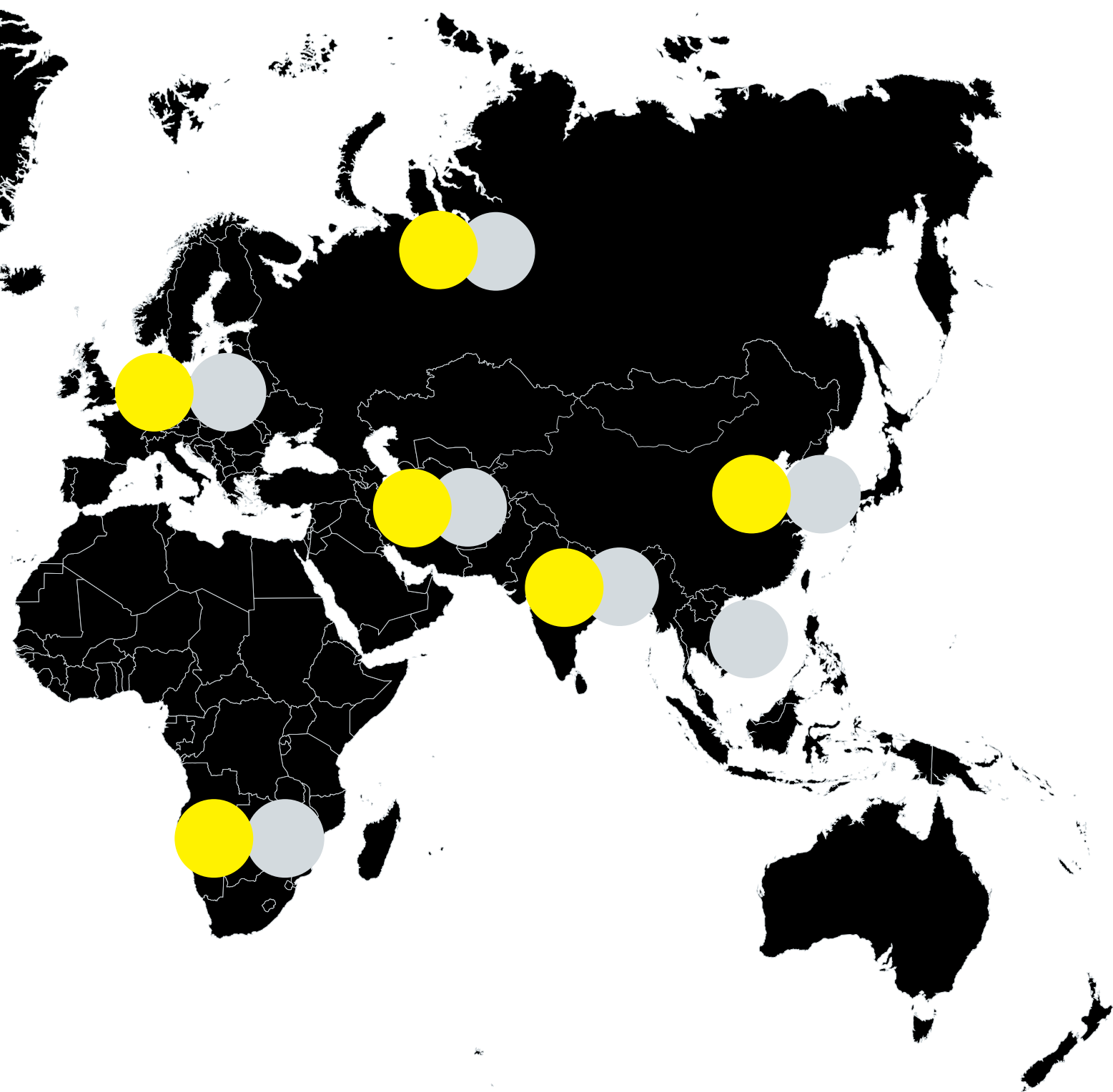

 **Global production footprint**

 **Global sales and service**



Just scan this QR code with your smartphone or visit our website at: [www.kelvion.com](http://www.kelvion.com) – there you will find a highly competent contact in your immediate vicinity.

[www.kelvion.com](http://www.kelvion.com)