

ENCLOSURES ARE AVAILABLE IN
1 FT. TO 8 FT. LENGTHS
IN 6 IN. INCREMENTS

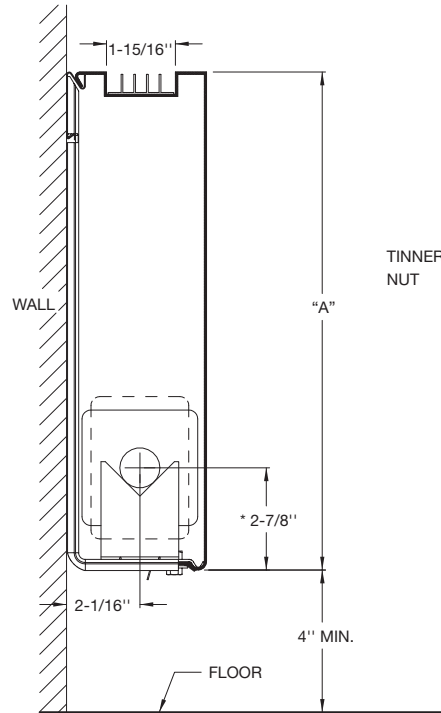

* CENTERLINES BASED ON 1" COPPER TUBE

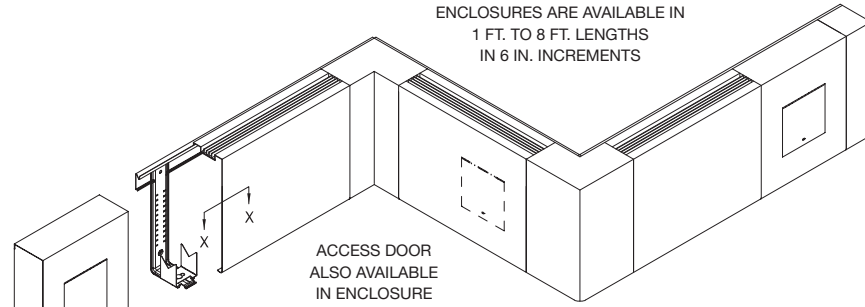
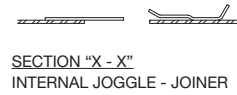
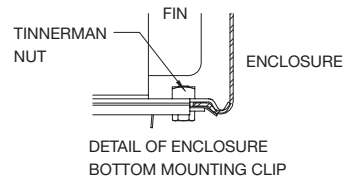
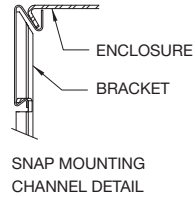

ACCESSORIES

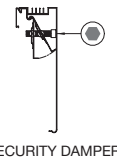
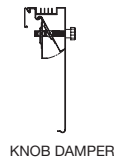
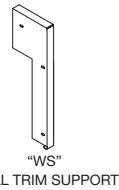
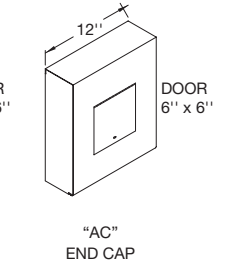
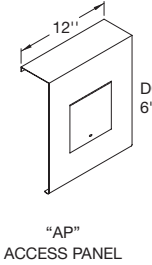
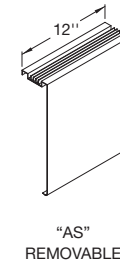
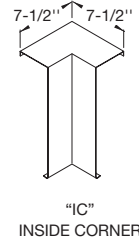
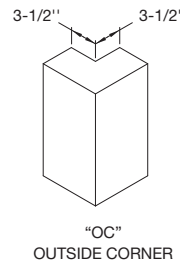
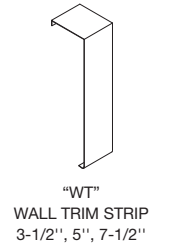
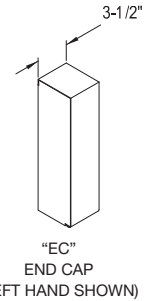
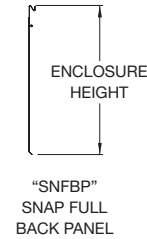
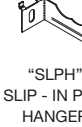
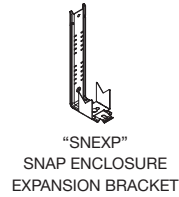
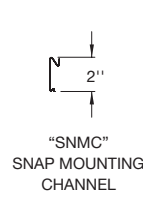

NOTE:
1) ALL ACCESSORIES OVERLAP (EXCEPT AS NOTED)
2) BUTT TYPE (INTERLOCKING) STYLE OPTIONAL (EXCEPT AS NOTED)



MODEL	PIPE SIZE		FIN SIZE	A
	STEEL	COPPER		
BG3	N/A	3/4", 1", 1-1/4"	2-3/4" x 4"	8"
	1", 1-1/4"	3/4", 1", 1-1/4"	3-1/4" x 3-1/4"	11"
				14"

CONTRACTOR _____ ELEMENT _____

ARCHITECT _____ RATING _____ BTU _____ A.W.T. _____ E.A.T. _____

ENGINEER _____ BACKPLATE _____ FULL _____ PARTIAL _____

REPRESENTATIVE _____ ENCL. GAUGE _____ MATERIAL _____

LOCATION _____ COLOR _____ DAMPER _____

ZEHNDER RITTLING
100 RITTLING BLVD. • BUFFALO, NY USA 14220

JOB:

ENCLOSURE MODEL: **BG3**

DATE: **January 2011**

DWG.NO.: **BG3**

zehnder Rittling

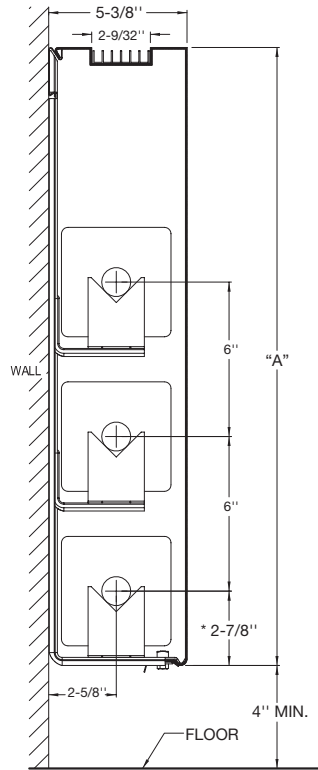

* CENTERLINES BASED ON 1" COPPER TUBE

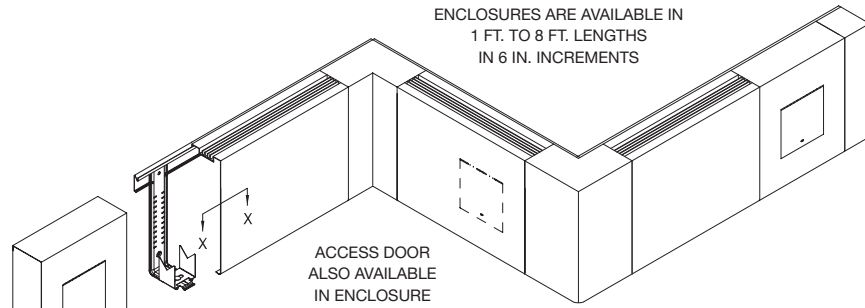
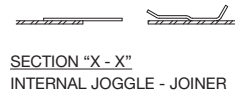
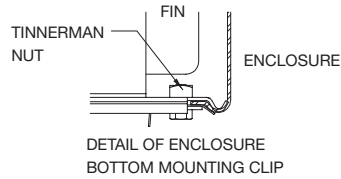
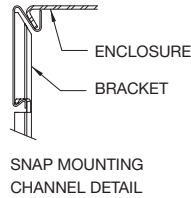

ACCESSORIES

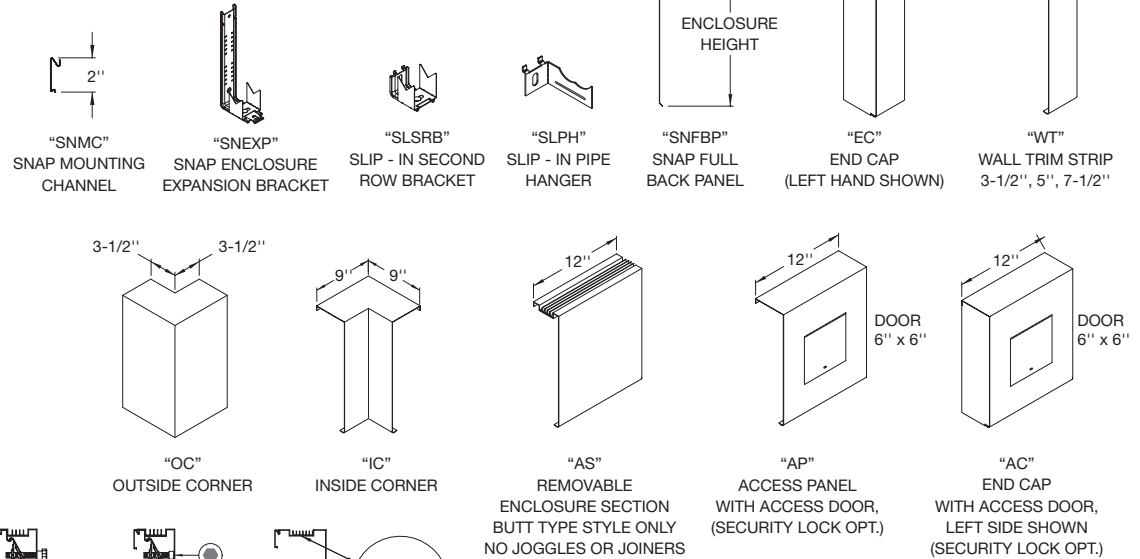

NOTE:
1) ALL ACCESSORIES OVERLAP (EXCEPT AS NOTED)
2) BUTT TYPE (INTERLOCKING) STYLE OPTIONAL (EXCEPT AS NOTED)



MODEL	PIPE SIZE		FIN SIZE	A
	STEEL	COPPER		
BG5	N/A	3/4", 1", 1-1/4"	2-3/4" x 4"	14"
	1", 1-1/4"	3/4", 1", 1-1/4"	3-1/4", x 3-1/4"	20"
	1", 1-1/4", 2"	3/4", 1", 1-1/4"	4-1/4" x 4-1/4"	24"

CONTRACTOR _____ ELEMENT _____

ARCHITECT _____ RATING _____ BTU _____ A.W.T. _____ E.A.T. _____

ENGINEER _____ BACKPLATE _____ FULL _____ PARTIAL _____

REPRESENTATIVE _____ ENCL. GAUGE _____ MATERIAL _____

LOCATION _____ COLOR _____ DAMPER _____

ZEHNDER RITTLING
100 RITTLING BLVD. • BUFFALO, NY USA 14220

JOB:

ENCLOSURE MODEL: **BG5**

DATE: **January 2011**

DWG.NO.: **BG5**

ENCLOSURES ARE AVAILABLE IN
1 FT. TO 8 FT. LENGTHS
IN 6 IN. INCREMENTS

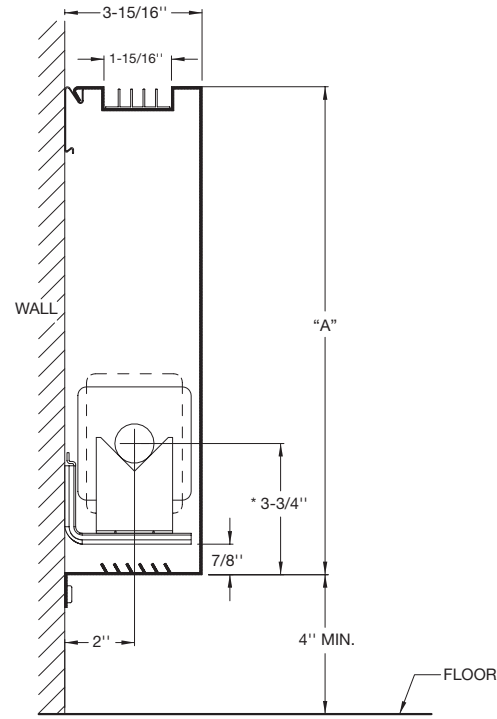
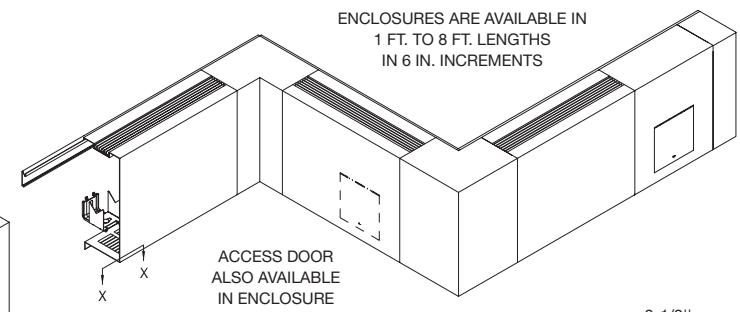

* CENTERLINES BASED ON 1" COPPER TUBE

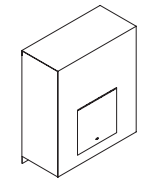
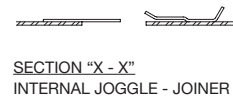
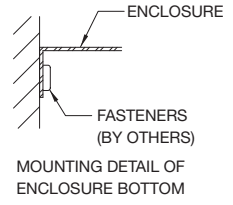
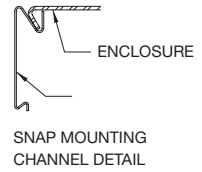

ACCESSORIES

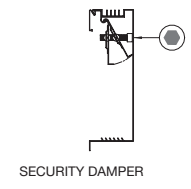
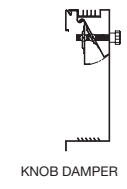
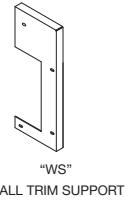
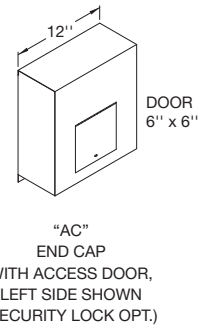
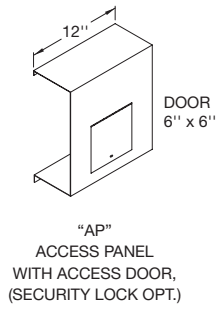
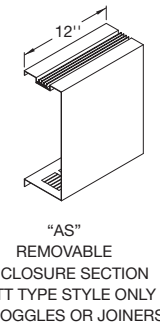
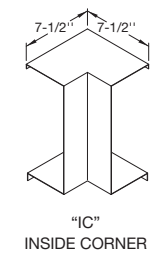
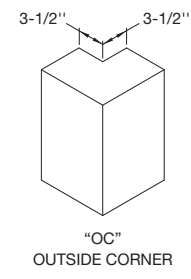
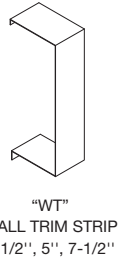
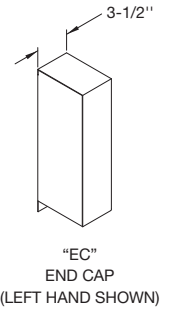
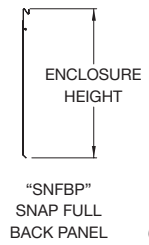
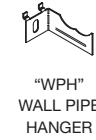
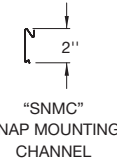

NOTE:
1) ALL ACCESSORIES OVERLAP
(EXCEPT AS NOTED)
2) BUTT TYPE (INTERLOCKING) STYLE OPTIONAL
(EXCEPT AS NOTED)



MODEL	PIPE SIZE		FIN SIZE	A
	STEEL	COPPER		
BGHL3	N/A	3/4", 1", 1-1/4"	2-3/4" x 4"	8"
	1", 1-1/4"	3/4", 1", 1-1/4"	3-1/4" x 3-1/4"	11"
				14"

CONTRACTOR _____ ELEMENT _____

ARCHITECT _____ RATING _____ BTU _____ A.W.T. _____ E.A.T. _____

ENGINEER _____ BACKPLATE _____ FULL _____ PARTIAL _____

REPRESENTATIVE _____ ENCL. GAUGE _____ MATERIAL _____

LOCATION _____ COLOR _____ DAMPER _____

ZEHNDER RITTLING
100 RITTLING BLVD. • BUFFALO, NY USA 14220

JOB: _____

ENCLOSURE MODEL: **BGHL3**

DATE: **January 2011** DWG.NO.: **BGHL3**

zehnder
Rittling

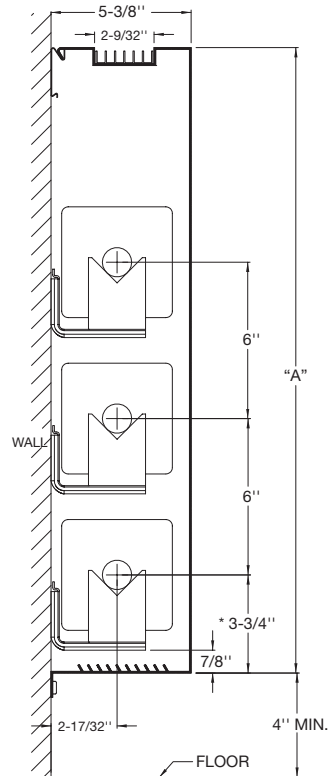

* CENTERLINES BASED ON 1" COPPER TUBE

MODEL	PIPE SIZE		FIN SIZE	A
	STEEL	COPPER		
BGHL5	N/A	3/4", 1", 1-1/4"	2-3/4" x 4"	14"
	1", 1-1/4"	3/4", 1", 1-1/4"	3-1/4", x 3-1/4"	20"
	1", 1-1/4", 2"	3/4", 1", 1-1/4"	4-1/4" x 4-1/4"	24"

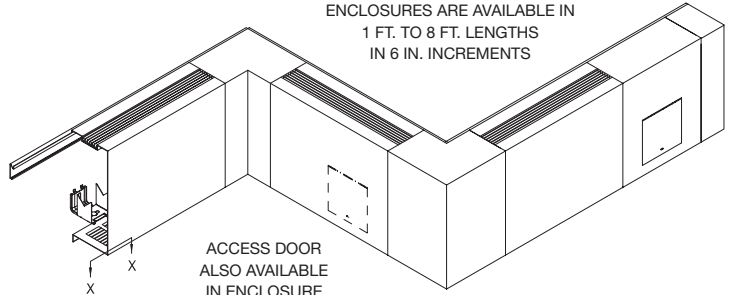
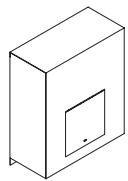
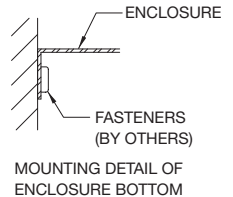
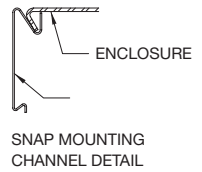

ACCESSORIES

"SNMC" SNAP MOUNTING CHANNEL

"SLSRB" SLIP - IN SECOND ROW BRACKET

"WPH" WALL PIPE HANGER

"SNFBP" SNAP FULL BACK PANEL

"EC" END CAP (LEFT HAND SHOWN)

"WT" WALL TRIM STRIP 3-1/2", 5", 7-1/2"

"OC" OUTSIDE CORNER

"IC" INSIDE CORNER

"AS" REMOVABLE ENCLOSURE SECTION BUTT TYPE STYLE ONLY NO JOGGLES OR JOINERS

"AP" ACCESS PANEL WITH ACCESS DOOR, (SECURITY LOCK OPT.)

"AC" END CAP WITH ACCESS DOOR, LEFT SIDE SHOWN (SECURITY LOCK OPT.)

"WS" WALL TRIM SUPPORT

KNOB DAMPER

SECURITY DAMPER

SLIDE DAMPER

NOTE:
1) ALL ACCESSORIES OVERLAP (EXCEPT AS NOTED)
2) BUTT TYPE (INTERLOCKING) STYLE OPTIONAL (EXCEPT AS NOTED)



CONTRACTOR _____ ELEMENT _____

ARCHITECT _____ RATING _____ BTU _____ A.W.T. _____ E.A.T. _____

ENGINEER _____ BACKPLATE _____ FULL _____ PARTIAL _____

REPRESENTATIVE _____ ENCL. GAUGE _____ MATERIAL _____

LOCATION _____ COLOR _____ DAMPER _____

ZEHNDER RITTLING
100 RITTLING BLVD. • BUFFALO, NY USA 14220

JOB: _____

ENCLOSURE MODEL: **BGHL5**

DATE: **January 2011** | DWG.NO.: **BGHL5**

ENCLOSURES ARE AVAILABLE IN
1 FT. TO 8 FT. LENGTHS
IN 6 IN. INCREMENTS

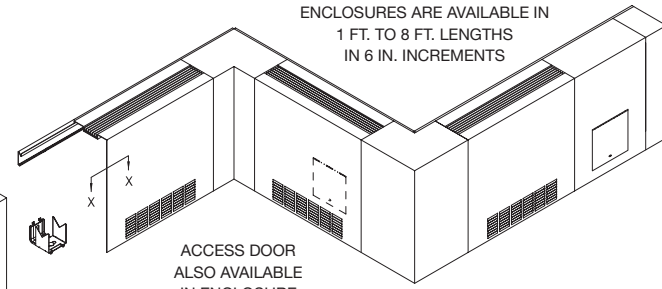

ACCESS DOOR
ALSO AVAILABLE
IN ENCLOSURE

ACCESSORIES

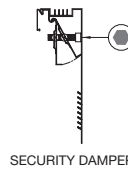
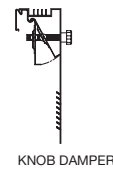
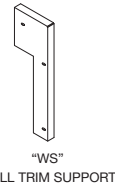
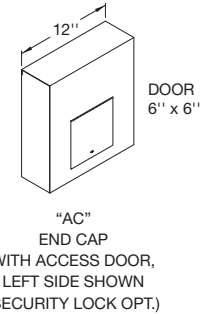
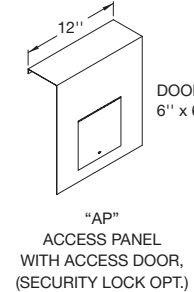
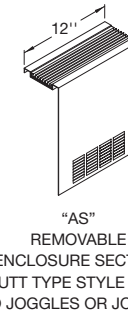
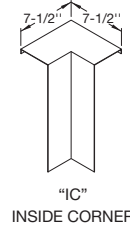
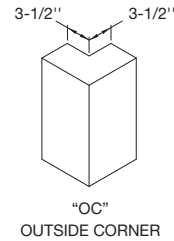
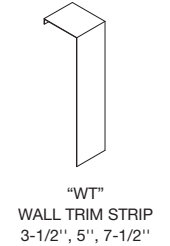
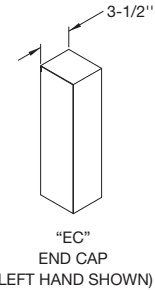
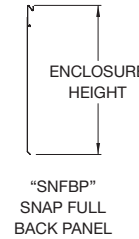
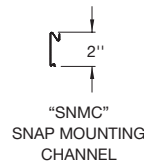
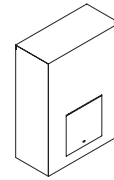
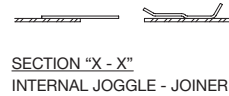
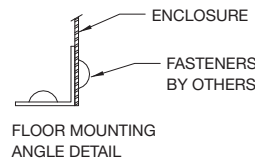
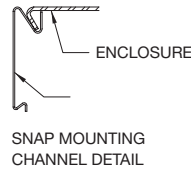
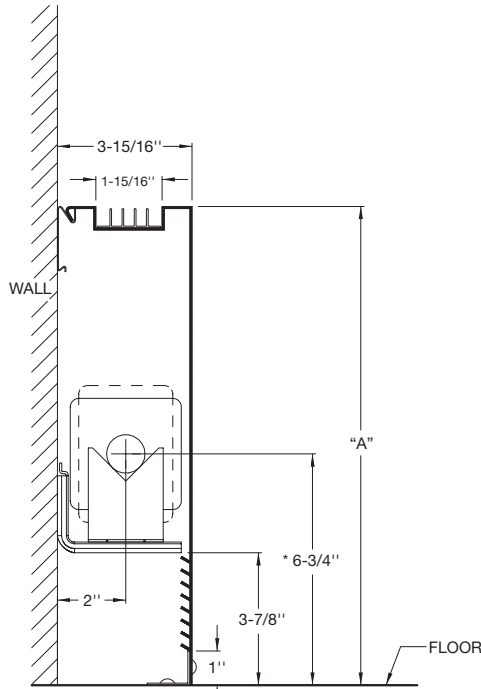

- NOTE:
1) ALL ACCESSORIES OVERLAP (EXCEPT AS NOTED)
2) BUTT TYPE (INTERLOCKING) STYLE OPTIONAL (EXCEPT AS NOTED)
3) CONSULT FACTORY ON DAMPER AVAILABILITY



MODEL	PIPE SIZE		FIN SIZE	A
	STEEL	COPPER		
BGVL3	N/A	3/4", 1", 1-1/4"	2-3/4" x 4"	11"
	1", 1-1/4"	3/4", 1", 1-1/4"	3-1/4" x 3-1/4"	14"

CONTRACTOR _____ ELEMENT _____

ARCHITECT _____ RATING _____ BTU _____ A.W.T. _____ E.A.T. _____

ENGINEER _____ BACKPLATE _____ FULL _____ PARTIAL _____

REPRESENTATIVE _____ ENCL. GAUGE _____ MATERIAL _____

LOCATION _____ COLOR _____ DAMPER _____

ZEHNDER RITTLING
100 RITTLING BLVD. • BUFFALO, NY USA 14220

JOB:

ENCLOSURE MODEL: **BGVL3**

DATE: **January 2011**

DWG.NO.: **BGVL3**

zehnder

Rittling

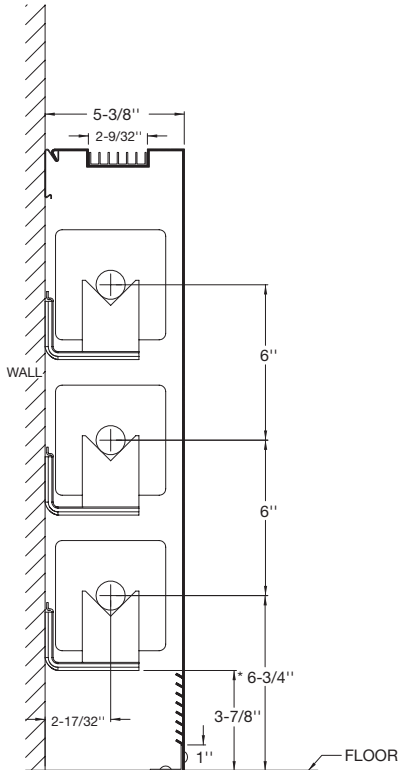

* CENTERLINES BASED ON 1" COPPER TUBE

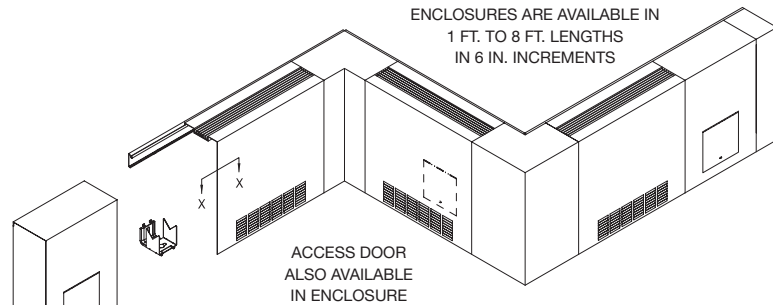
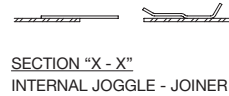
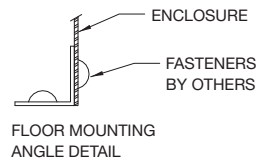
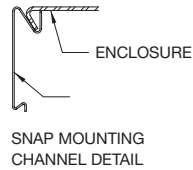

ACCESSORIES

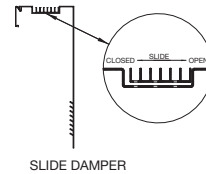
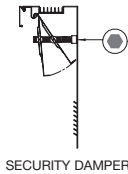
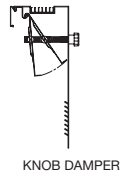
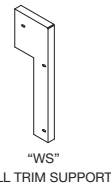
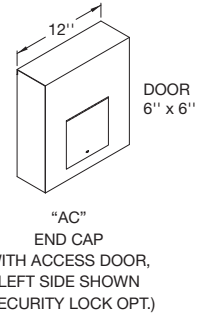
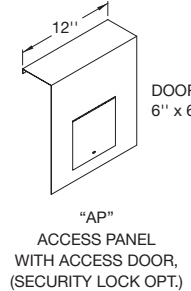
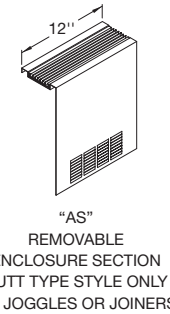
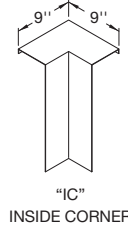
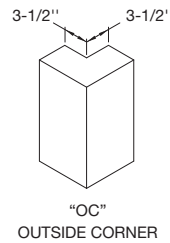
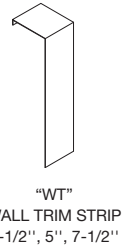
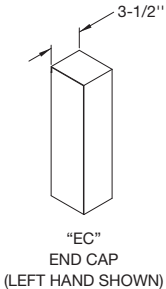
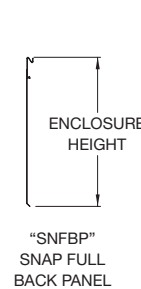
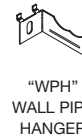
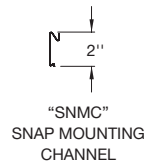

NOTE:
1) ALL ACCESSORIES OVERLAP (EXCEPT AS NOTED)
2) BUTT TYPE (INTERLOCKING) STYLE OPTIONAL (EXCEPT AS NOTED)
3) CONSULT FACTORY ON DAMPER AVAILABILITY



MODEL	PIPE SIZE		FIN SIZE	A
	STEEL	COPPER		
BGVL5	N/A	3/4", 1", 1-1/4"	2-3/4" x 4"	14"
	1", 1-1/4"	3/4", 1", 1-1/4"	3-1/4", x 3-1/4"	20"
	1", 1-1/4", 2"	3/4", 1", 1-1/4"	4-1/4" x 4-1/4"	24"

CONTRACTOR _____ ELEMENT _____

ARCHITECT _____ RATING _____ BTU _____ A.W.T. _____ E.A.T. _____

ENGINEER _____ BACKPLATE _____ FULL _____ PARTIAL _____

REPRESENTATIVE _____ ENCL. GAUGE _____ MATERIAL _____

LOCATION _____ COLOR _____ DAMPER _____

ZEHNDER RITTLING
100 RITTLING BLVD. • BUFFALO, NY USA 14220

JOB:

ENCLOSURE MODEL: **BGVL5**

DATE: **January 2011**

DWG.NO.: **BGVL5**

ENCLOSURES ARE AVAILABLE IN
1 FT. TO 8 FT. LENGTHS
IN 6 IN. INCREMENTS

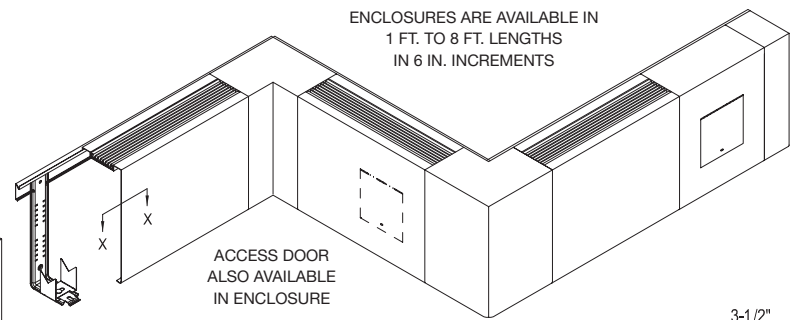

ACCESS DOOR
ALSO AVAILABLE
IN ENCLOSURE

ACCESSORIES

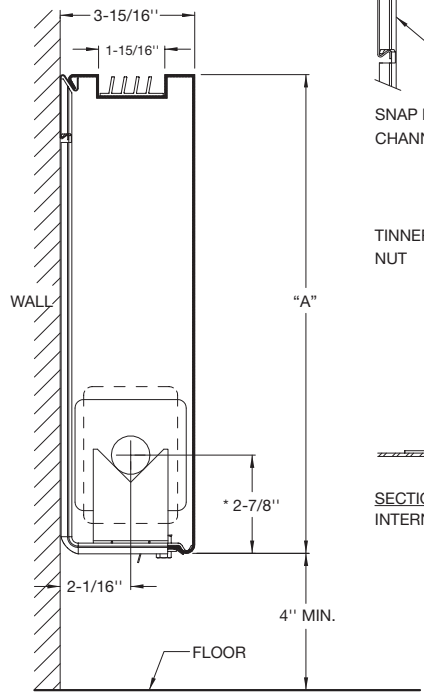

* CENTERLINES BASED ON 1" COPPER TUBE

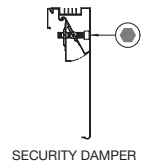
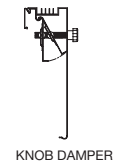
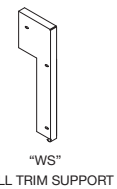
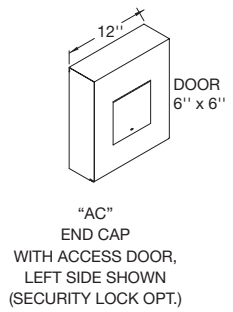
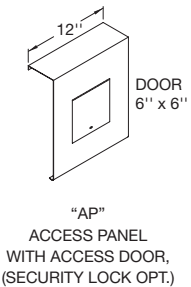
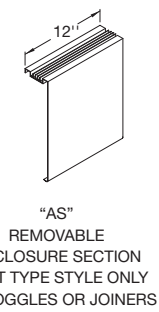
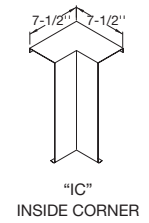
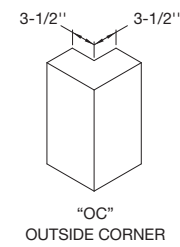
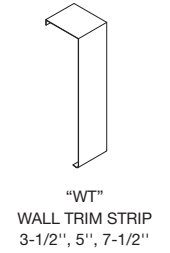
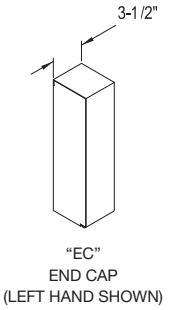
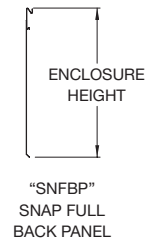
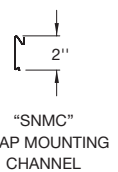
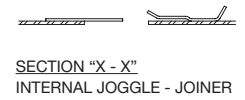
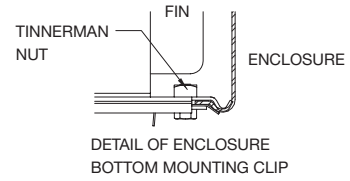
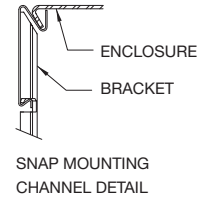

NOTE:
1) ALL ACCESSORIES OVERLAP
(EXCEPT AS NOTED)
2) BUTT TYPE (INTERLOCKING) STYLE OPTIONAL
(EXCEPT AS NOTED)



MODEL	PIPE SIZE		FIN SIZE	A
	STEEL	COPPER		
IBG3	N/A	3/4", 1", 1-1/4"	2-3/4" x 4"	8"
	1", 1-1/4"	3/4", 1", 1-1/4"	3-1/4" x 3-1/4"	11"
				14"

CONTRACTOR _____ ELEMENT _____
 ARCHITECT _____ RATING _____ BTU _____ A.W.T. _____ E.A.T. _____
 ENGINEER _____ BACKPLATE _____ FULL _____ PARTIAL _____
 REPRESENTATIVE _____ ENCL. GAUGE _____ MATERIAL _____
 LOCATION _____ COLOR _____ DAMPER _____

ZEHNDER RITTLING
100 RITTLING BLVD. • BUFFALO, NY USA 14220

JOB: _____

ENCLOSURE MODEL: **IBG3**

DATE: **January 2011** | DWG.NO.: **IBG3**

zehnder Rittling

ENCLOSURES ARE AVAILABLE IN
1 FT. TO 8 FT. LENGTHS
IN 6 IN. INCREMENTS

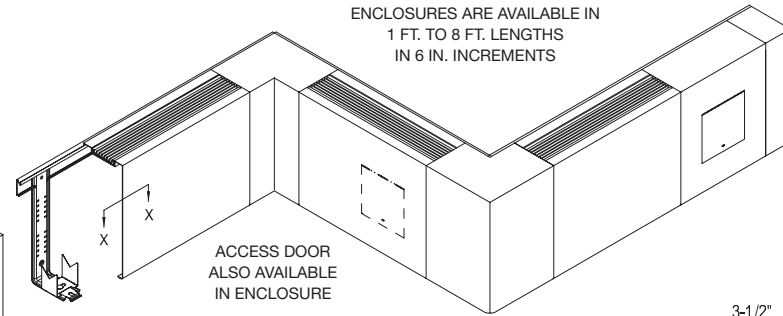

ACCESS DOOR
ALSO AVAILABLE
IN ENCLOSURE

ACCESSORIES

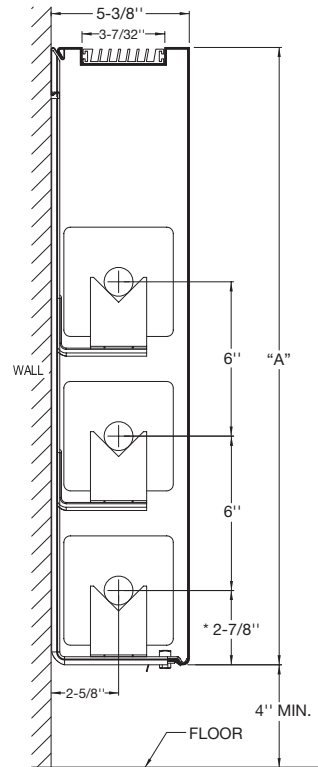

* CENTERLINES BASED ON 1" COPPER TUBE

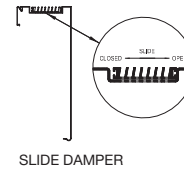
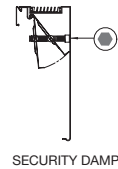
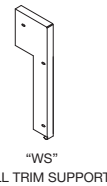
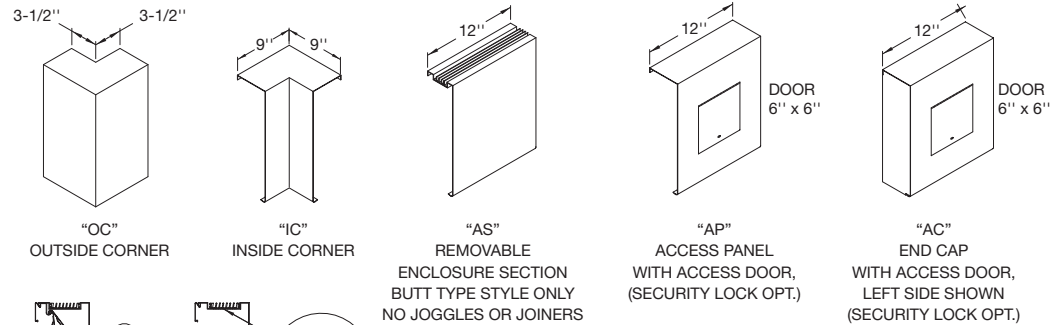
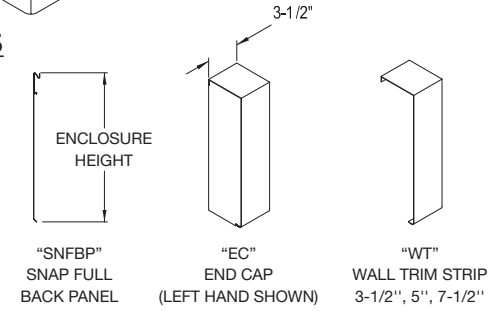
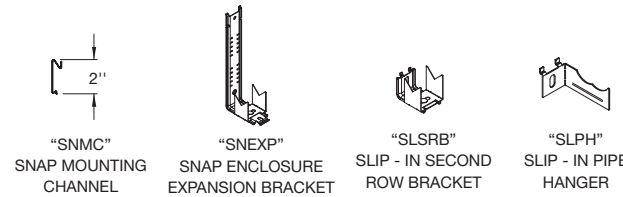
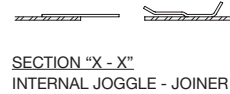
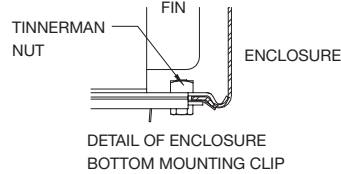
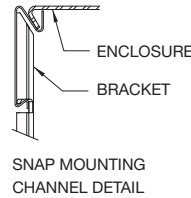

NOTE:
1) ALL ACCESSORIES OVERLAP
(EXCEPT AS NOTED)
2) BUTT TYPE (INTERLOCKING) STYLE OPTIONAL
(EXCEPT AS NOTED)



MODEL	PIPE SIZE		FIN SIZE	A
	STEEL	COPPER		
IBG5	N/A	3/4", 1", 1-1/4"	2-3/4" x 4"	14"
	1", 1-1/4"	3/4", 1", 1-1/4"	3-1/4", x 3-1/4"	20"
	1", 1-1/4", 2"	3/4", 1", 1-1/4"	4-1/4" x 4-1/4"	24"

CONTRACTOR _____ ELEMENT _____

ARCHITECT _____ RATING _____ BTU _____ A.W.T. _____ E.A.T. _____

ENGINEER _____ BACKPLATE _____ FULL _____ PARTIAL _____

REPRESENTATIVE _____ ENCL. GAUGE _____ MATERIAL _____

LOCATION _____ COLOR _____ DAMPER _____

ZEHNDER RITTLING
100 RITTLING BLVD. • BUFFALO, NY USA 14220

JOB: _____

ENCLOSURE MODEL: **IBG5**

DATE: **January 2011** DWG.NO.: **IBG5**

ENCLOSURES ARE AVAILABLE IN
1 FT. TO 8 FT. LENGTHS
IN 6 IN. INCREMENTS

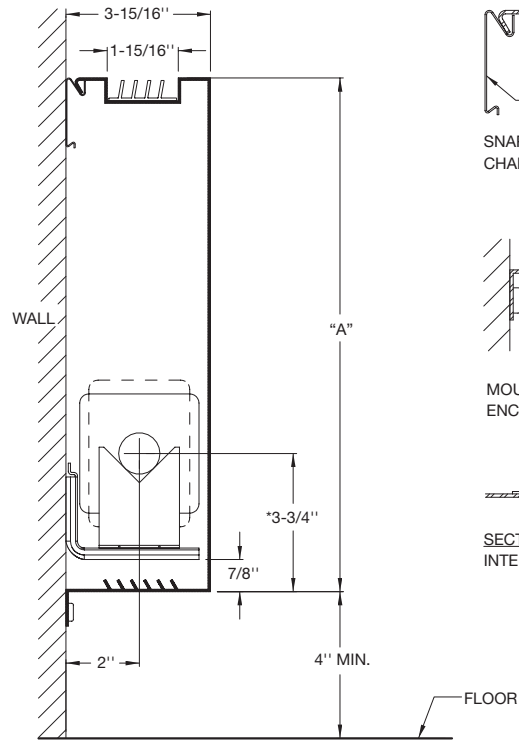

* CENTERLINES BASED ON 1" COPPER TUBE

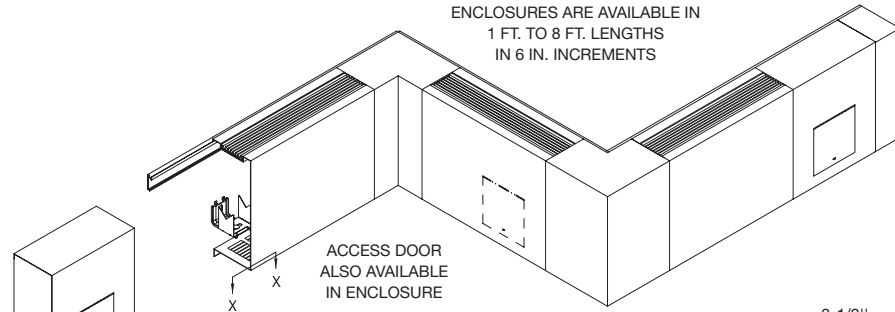
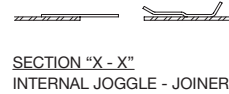
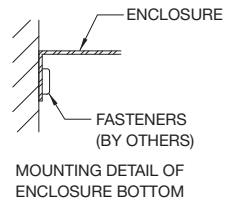
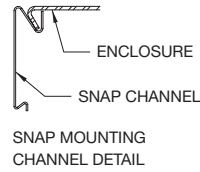

ACCESSORIES

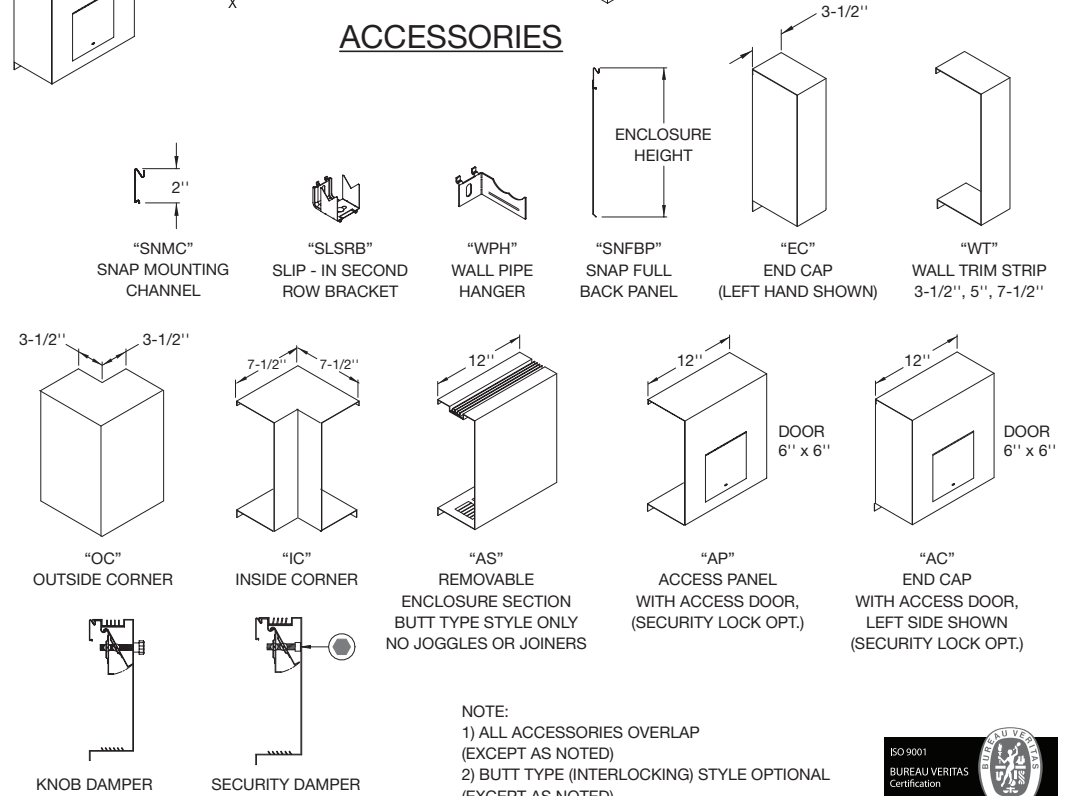

NOTE:
1) ALL ACCESSORIES OVERLAP (EXCEPT AS NOTED)
2) BUTT TYPE (INTERLOCKING) STYLE OPTIONAL (EXCEPT AS NOTED)



MODEL	PIPE SIZE		FIN SIZE	A
	STEEL	COPPER		
IBGHL3	N/A	3/4", 1", 1-1/4"	2-3/4" x 4"	8"
	1", 1-1/4"	3/4", 1", 1-1/4"	3-1/4" x 3-1/4"	11"
				14"

CONTRACTOR _____ ELEMENT _____
 ARCHITECT _____ RATING _____ BTU _____ A.W.T. _____ E.A.T. _____
 ENGINEER _____ BACKPLATE _____ FULL _____ PARTIAL _____
 REPRESENTATIVE _____ ENCL. GAUGE _____ MATERIAL _____
 LOCATION _____ COLOR _____ DAMPER _____

ZEHNDER RITTLING
100 RITTLING BLVD. • BUFFALO, NY USA 14220

JOB:

ENCLOSURE MODEL: **IBGHL3**

DATE: **January 2011**

DWG.NO.: **IBGHL3**

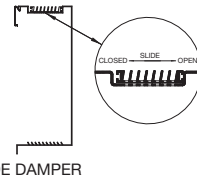
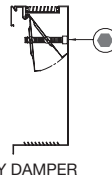
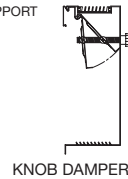
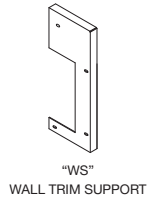
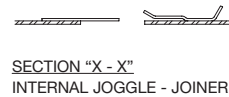
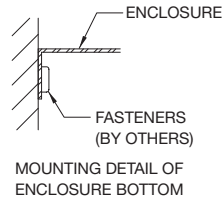
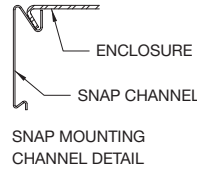
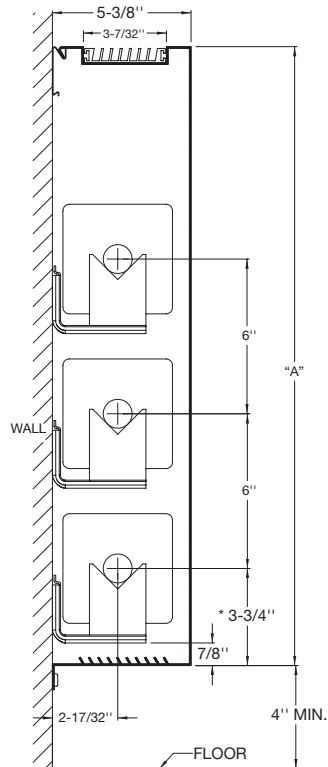

ENCLOSURES ARE AVAILABLE IN
1 FT. TO 8 FT. LENGTHS
IN 6 IN. INCREMENTS

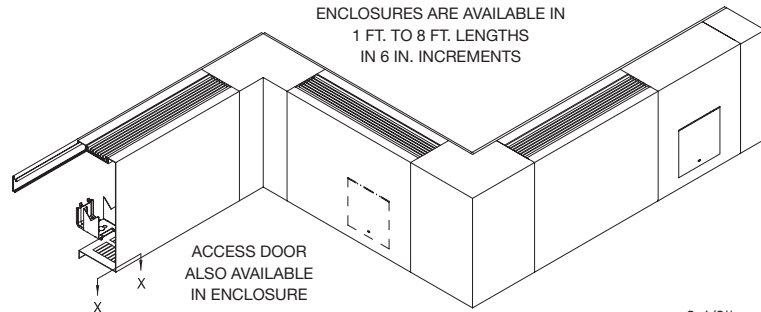

ACCESSORIES

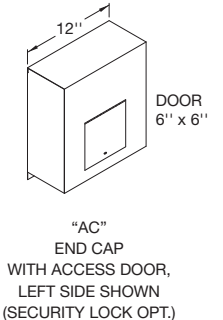
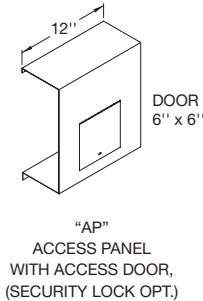
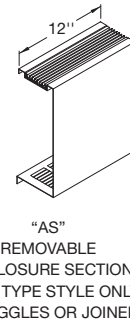
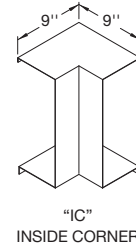
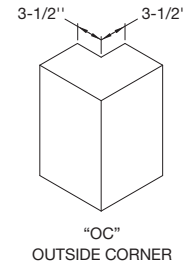
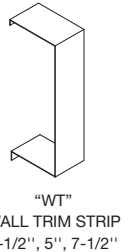
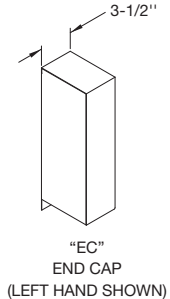
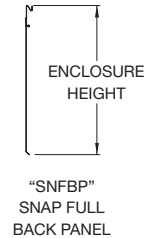
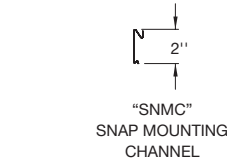

- NOTE:
1) ALL ACCESSORIES OVERLAP (EXCEPT AS NOTED)
2) BUTT TYPE (INTERLOCKING) STYLE OPTIONAL (EXCEPT AS NOTED)



MODEL	PIPE SIZE		FIN SIZE	A
	STEEL	COPPER		
IBGHL5	N/A	3/4", 1", 1-1/4"	2-3/4" x 4"	14"
	1", 1-1/4"	3/4", 1", 1-1/4"	3-1/4", x 3-1/4"	20"
	1", 1-1/4", 2"	3/4", 1", 1-1/4"	4-1/4" x 4-1/4"	24"

CONTRACTOR _____ ELEMENT _____
 ARCHITECT _____ RATING _____ BTU _____ A.W.T. _____ E.A.T. _____
 ENGINEER _____ BACKPLATE _____ FULL _____ PARTIAL _____
 REPRESENTATIVE _____ ENCL. GAUGE _____ MATERIAL _____
 LOCATION _____ COLOR _____ DAMPER _____

ZEHNDER RITTLING
100 RITTLING BLVD. • BUFFALO, NY USA 14220

JOB:

ENCLOSURE MODEL: **IBGHL5**

DATE: **January 2011**

DWG.NO.: **IBGHL5**

ENCLOSURES ARE AVAILABLE IN
1 FT. TO 8 FT. LENGTHS
IN 6 IN. INCREMENTS

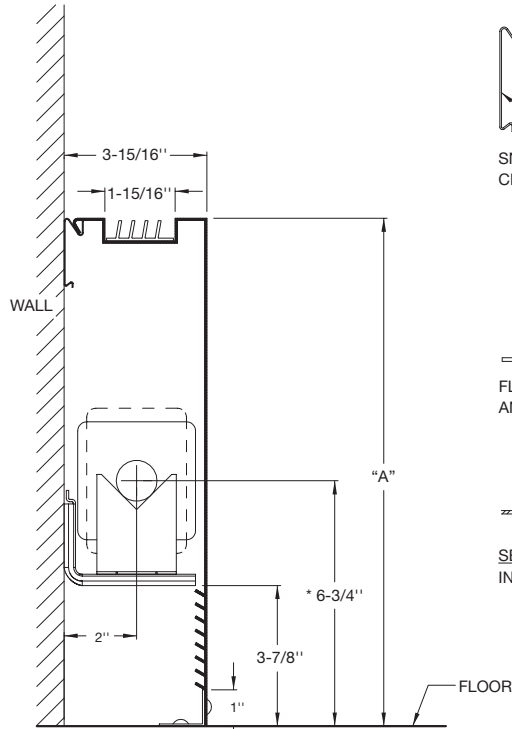
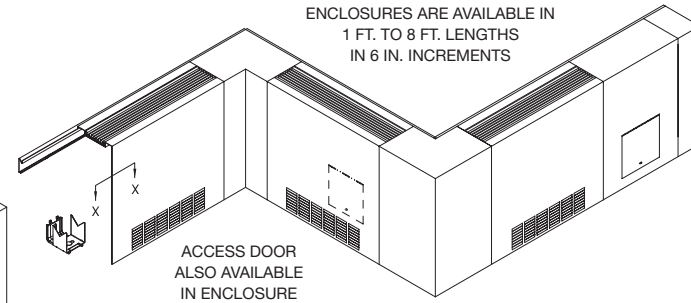

* CENTERLINES BASED ON 1" COPPER TUBE

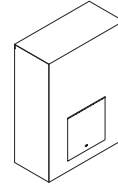
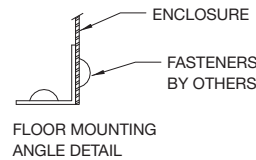
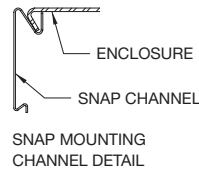

ACCESSORIES

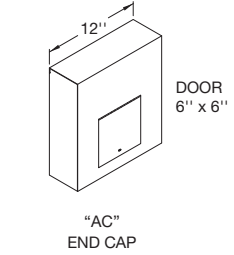
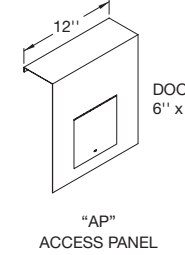
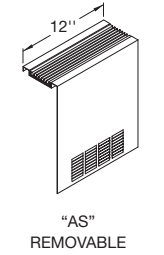
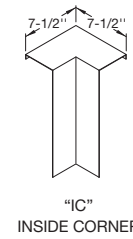
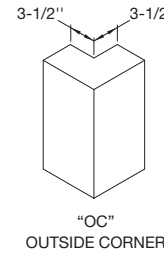
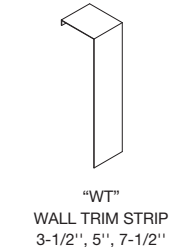
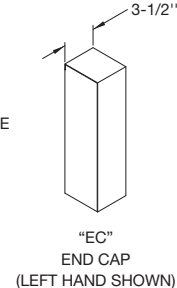
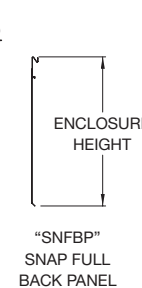
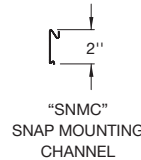

DOOR
6" x 6"

DOOR
6" x 6"



"WS"
WALL TRIM SUPPORT



KNOB DAMPER

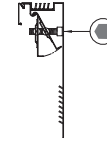

SECURITY DAMPER

NOTE:

- 1) ALL ACCESSORIES OVERLAP (EXCEPT AS NOTED)
- 2) BUTT TYPE (INTERLOCKING) STYLE OPTIONAL (EXCEPT AS NOTED)
- 3) CONSULT FACTORY ON DAMPER AVAILABILITY



MODEL	PIPE SIZE		FIN SIZE	A
	STEEL	COPPER		
IBGVL3	N/A	3/4", 1", 1-1/4"	2-3/4" x 4"	11
	1", 1-1/4"	3/4", 1", 1-1/4"	3-1/4" x 3-1/4"	14

CONTRACTOR _____ ELEMENT _____

ARCHITECT _____ RATING _____ BTU _____ A.W.T. _____ E.A.T. _____

ENGINEER _____ BACKPLATE _____ FULL _____ PARTIAL _____

REPRESENTATIVE _____ ENCL. GAUGE _____ MATERIAL _____

LOCATION _____ COLOR _____ DAMPER _____

ZEHNDER RITTLING
100 RITTLING BLVD. • BUFFALO, NY USA 14220

JOB:

ENCLOSURE MODEL: **IBGVL3**

DATE: **January 2011**

DWG.NO.: **IBGVL3**

ENCLOSURES ARE AVAILABLE IN
1 FT. TO 8 FT. LENGTHS
IN 6 IN. INCREMENTS

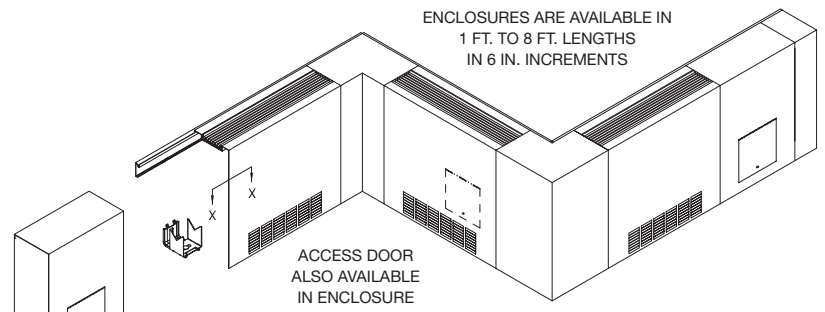
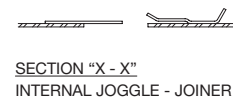
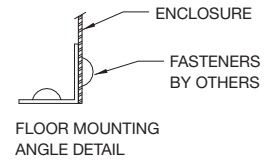
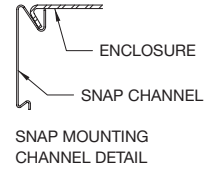
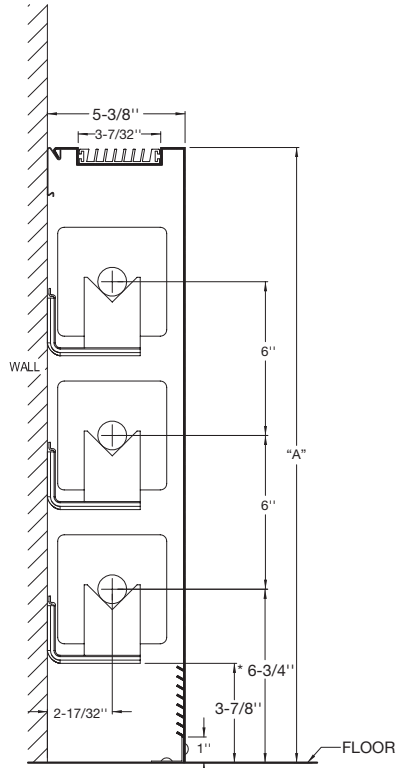

ACCESSORIES

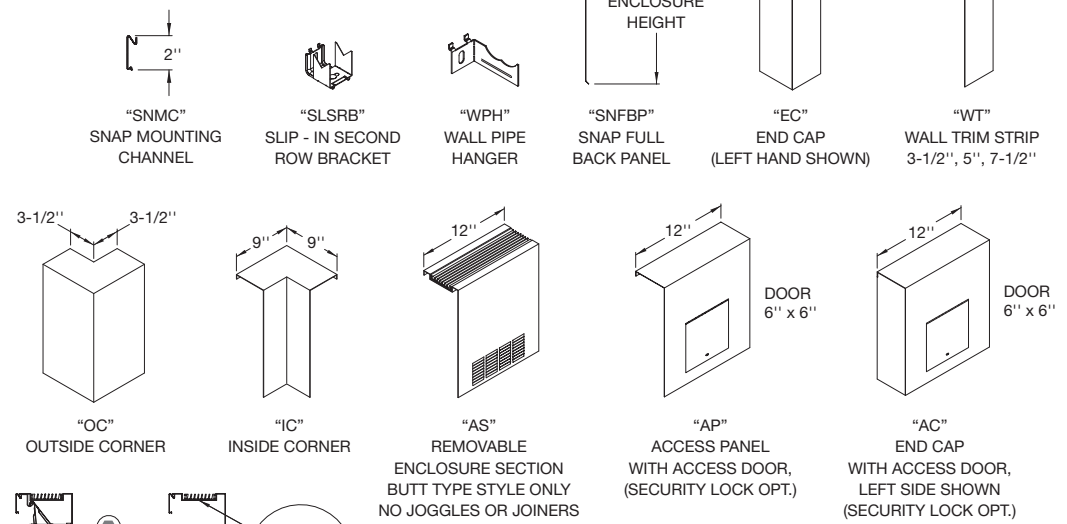

* CENTERLINES BASED ON 1" COPPER TUBE

MODEL	PIPE SIZE		FIN SIZE	A
	STEEL	COPPER		
IBGVL5	N/A	3/4", 1", 1-1/4"	2-3/4" x 4"	14
	1", 1-1/4"	3/4", 1", 1-1/4"	3-1/4", x 3-1/4"	20
	1", 1-1/4", 2"	3/4", 1", 1-1/4"	4-1/4" x 4-1/4"	24

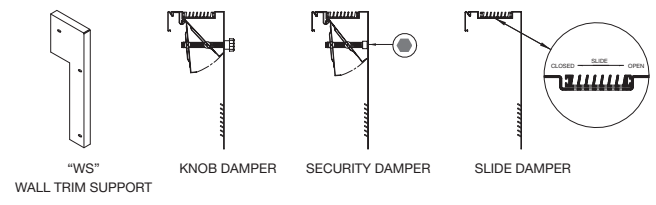

NOTE:
1) ALL ACCESSORIES OVERLAP (EXCEPT AS NOTED)
2) BUTT TYPE (INTERLOCKING) STYLE OPTIONAL (EXCEPT AS NOTED)
3) CONSULT FACTORY ON DAMPER AVAILABILITY



CONTRACTOR _____	ELEMENT _____	ZEHNDER RITTLING 100 RITTLING BLVD. • BUFFALO, NY USA 14220
ARCHITECT _____	RATING _____ BTU _____ A.W.T. _____ E.A.T. _____	JOB: _____
ENGINEER _____	BACKPLATE _____ FULL _____ PARTIAL _____	ENCLOSURE MODEL: IBGVL5
REPRESENTATIVE _____	ENCL. GAUGE _____ MATERIAL _____	DATE: January 2011
LOCATION _____	COLOR _____ DAMPER _____	DWG.NO.: IBGVL5

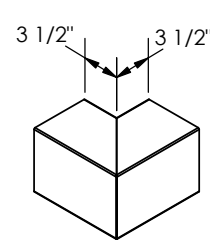
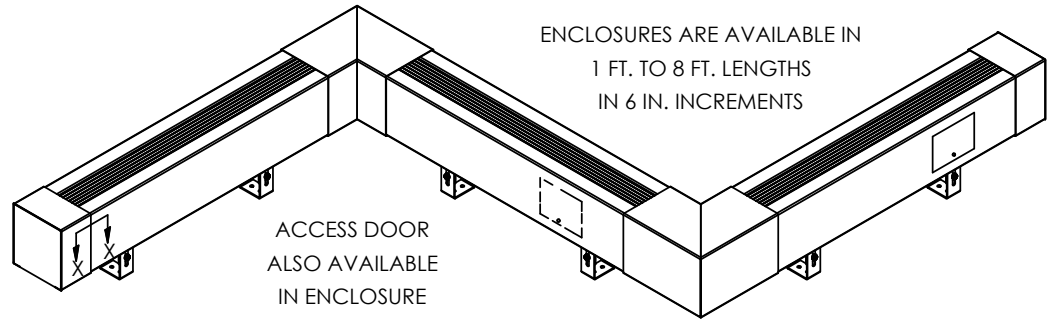
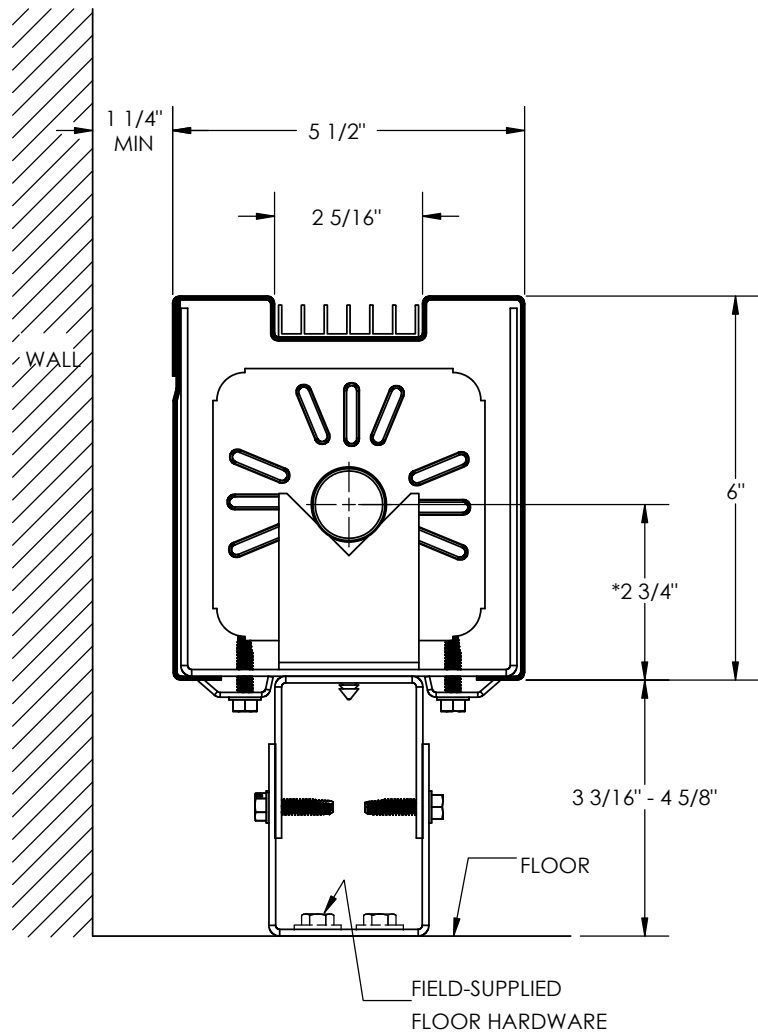

"OC"
OUTSIDE CORNER

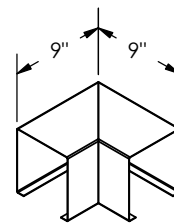

"IC"
INSIDE CORNER

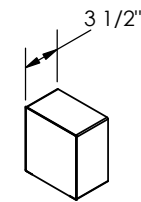

"EC"
END CAP
(LEFT HAND SHOWN)

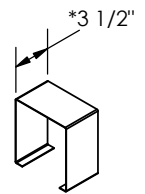

"WT"
WALL TRIP STRIP
*3-1/2", 5", 7-1/2"

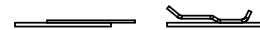

SECTION X-X
INTERNAL JOGGLE-JOINER

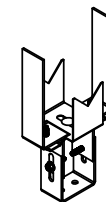

"PED - ADJ"
PEDESTAL 506 1 ROW
ADJUSTABLE BRACKET

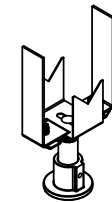

"PED - ALU"
PEDESTAL 506 1 ROW
ALUM FLANGE BRACKET

*CENTERLINES BASED ON 1" COPPER TUBE
4-1/4" SQ FIN SHOWN

NOTE:
1) ALL ACCESSORIES OVERLAP

CONTRACTOR _____	ELEMENT _____
ARCHITECT _____	RATING _____ B.T.U. _____ A.W.T. _____ E.A.T. _____
ENGINEER _____	BACKPLATE _____ FULL _____ PARTIAL _____
REPRESENTATIVE _____	ENCL. GAUGE _____ MATERIAL _____
LOCATION _____	COLOR _____ DAMPER _____

zehnder

**BUFFALO,
NEW YORK 14220**

MODEL: PBG506	MATERIAL:
JOB:	REVISION: -
DWG. NO.	DWN BY:
	DATE: May 2018

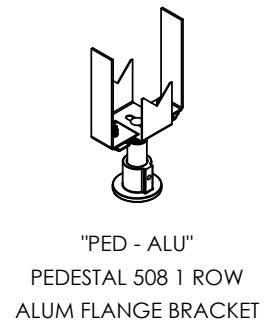
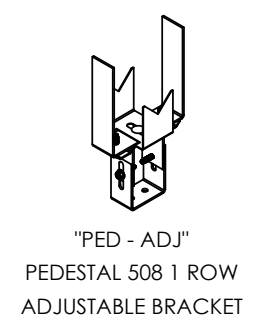
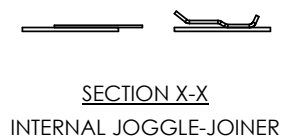
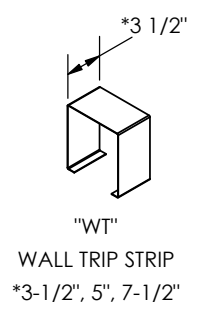
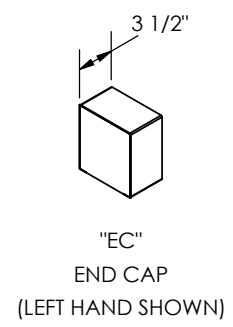
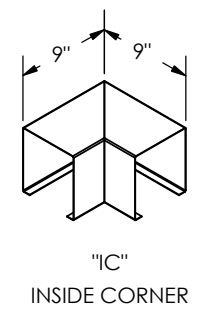
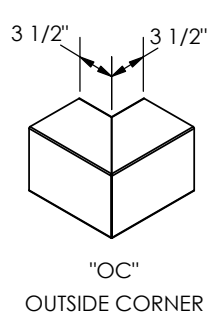
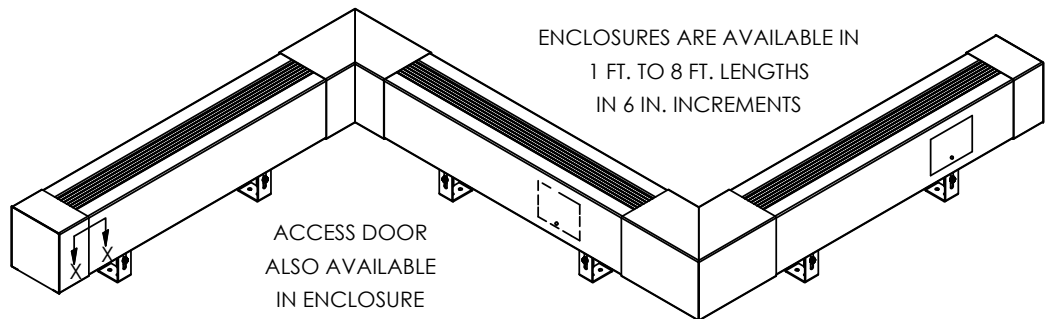
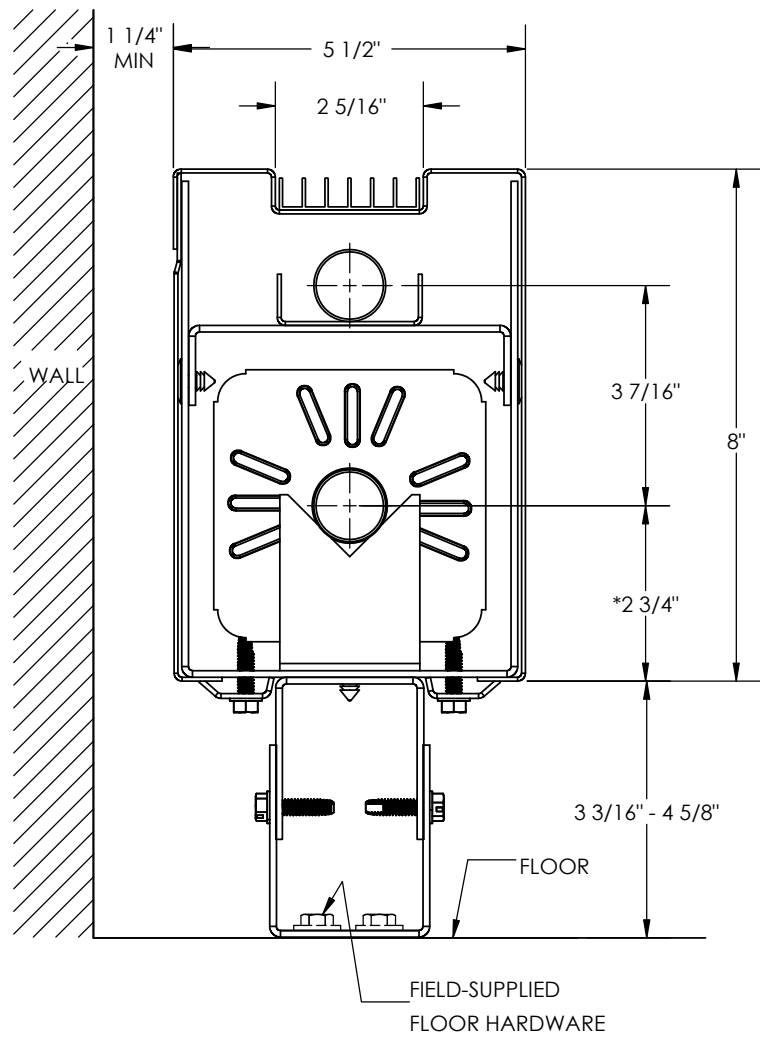

*CENTERLINES BASED ON 1" COPPER TUBE
4-1/4" SQ FIN SHOWN

NOTE:
1) ALL ACCESSORIES OVERLAP

CONTRACTOR _____	ELEMENT _____
ARCHITECT _____	RATING _____ B.T.U. _____ A.W.T. _____ E.A.T.
ENGINEER _____	BACKPLATE _____ FULL _____ PARTIAL _____
REPRESENTATIVE _____	ENCL. GAUGE _____ MATERIAL _____
LOCATION _____	COLOR _____ DAMPER _____

zehnder		BUFFALO, NEW YORK 14220	
MODEL: PBG508 with RETURN		MATERIAL:	
JOB:		REVISION: -	DWN BY:
DWG. NO.		DATE: May 2018	

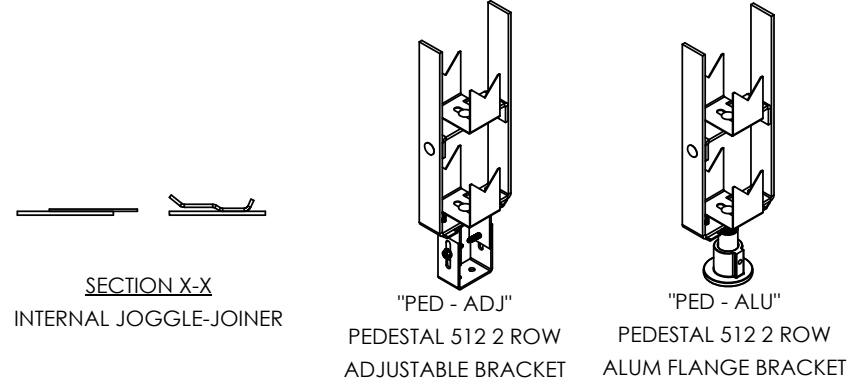
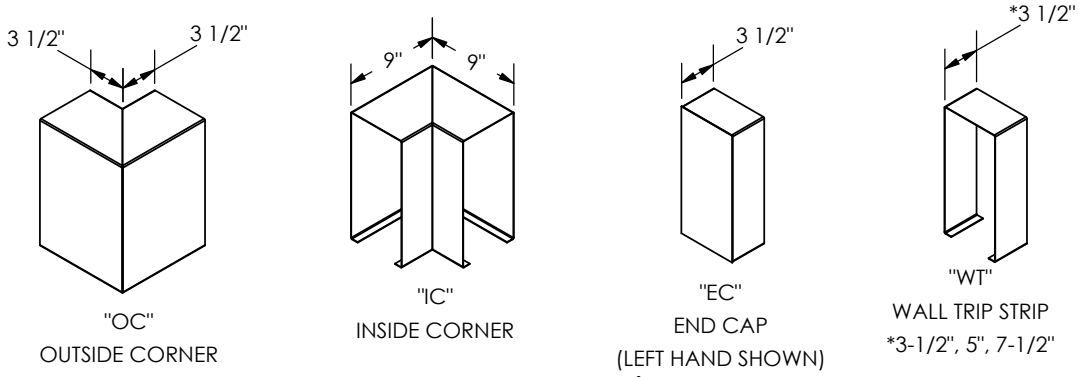
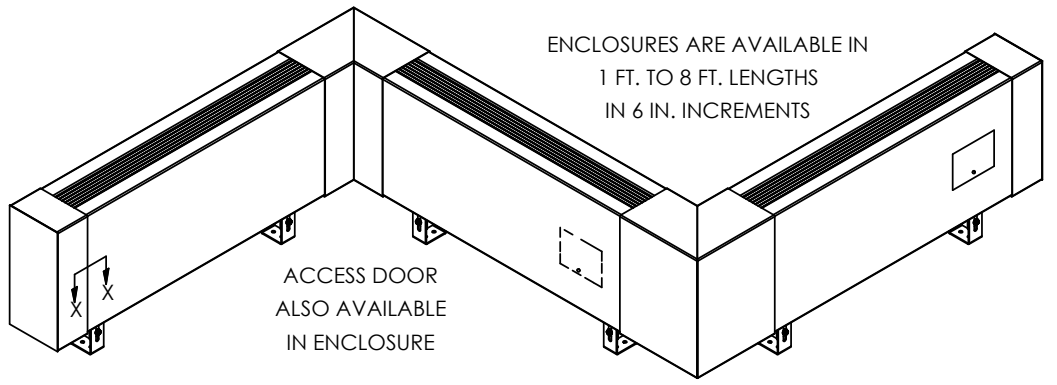
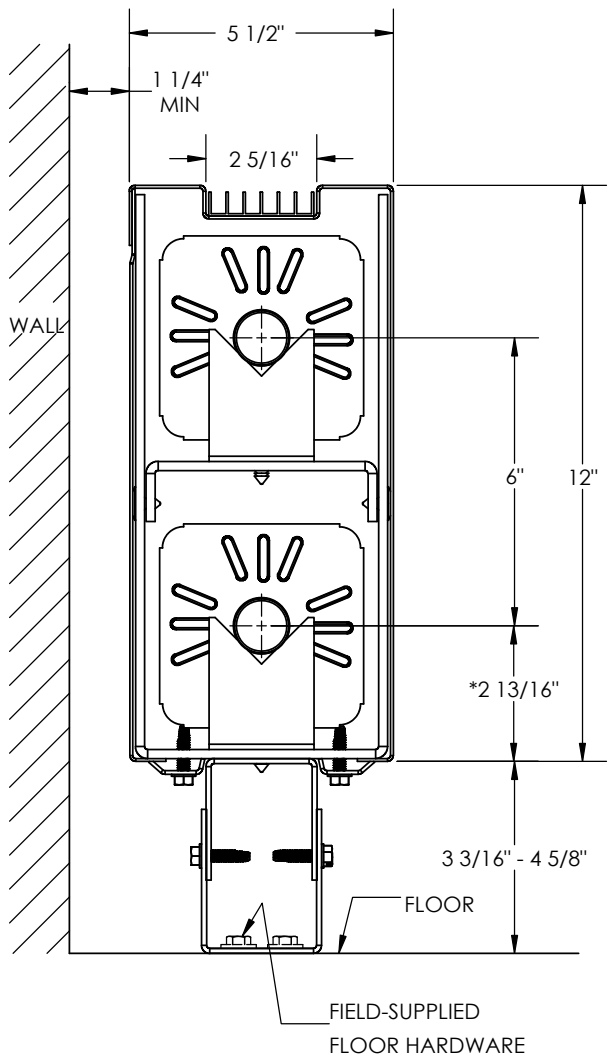

*CENTERLINES BASED ON 1" COPPER TUBE
4-1/4" SQ FIN SHOWN

NOTE:
1) ALL ACCESSORIES OVERLAP

CONTRACTOR _____	ELEMENT _____
ARCHITECT _____	RATING _____ B.T.U. _____ A.W.T. _____ E.A.T. _____
ENGINEER _____	BACKPLATE _____ FULL _____ PARTIAL _____
REPRESENTATIVE _____	ENCL. GAUGE _____ MATERIAL _____
LOCATION _____	COLOR _____ DAMPER _____

zehnder		BUFFALO, NEW YORK 14220	
MODEL: PBG512			MATERIAL:
JOB:		REVISION: -	DWN BY:
DWG. NO.		DATE:	May 2018

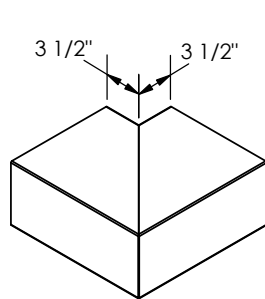
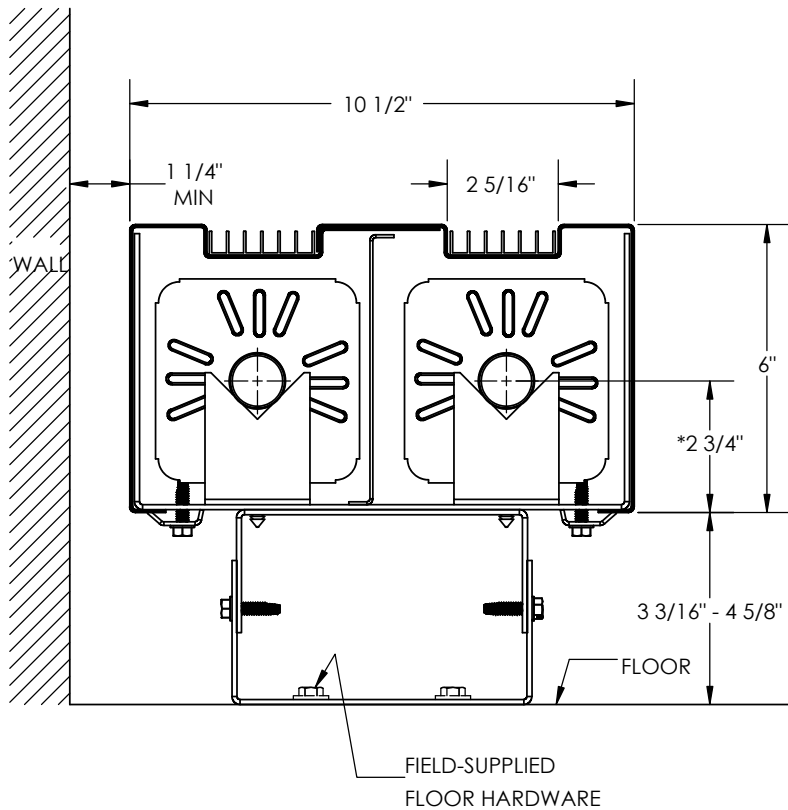
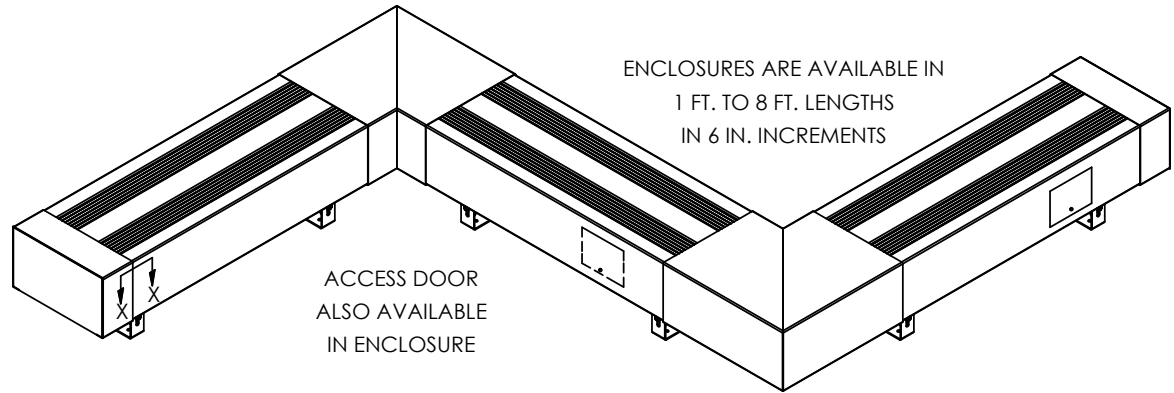

"OC"
OUTSIDE CORNER

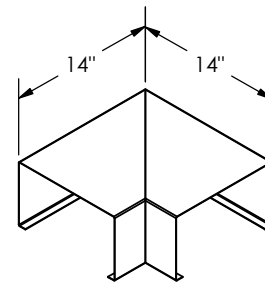

"IC"
INSIDE CORNER

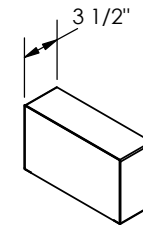

"EC"
END CAP
(LEFT HAND SHOWN)

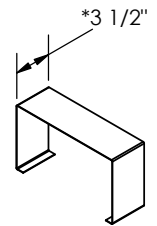

"WT"
WALL TRIP STRIP
*3-1/2", 5", 7-1/2"



SECTION X-X
INTERNAL JOGGLE-JOINER

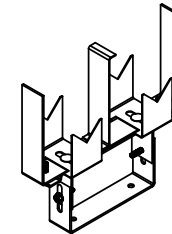

"PED - ADJ"
PEDESTAL 1006 2 COLUMN
ADJUSTABLE BRACKET

*CENTERLINES BASED ON 1" COPPER TUBE
4-1/4" SQ FIN SHOWN

NOTE:
1) ALL ACCESSORIES OVERLAP

CONTRACTOR _____	ELEMENT _____
ARCHITECT _____	RATING _____ B.T.U. _____ A.W.T. _____ E.A.T. _____
ENGINEER _____	BACKPLATE _____ FULL _____ PARTIAL _____
REPRESENTATIVE _____	ENCL. GAUGE _____ MATERIAL _____
LOCATION _____	COLOR _____ DAMPER _____

zehnder

**BUFFALO,
NEW YORK 14220**

MODEL:
PBG1006

JOB:

DWG. NO.

MATERIAL:

REVISION:
-

DWN BY:

DATE: May 2018

ENCLOSURES ARE AVAILABLE IN
1 FT. TO 8 FT. LENGTHS
IN 6 IN. INCREMENTS

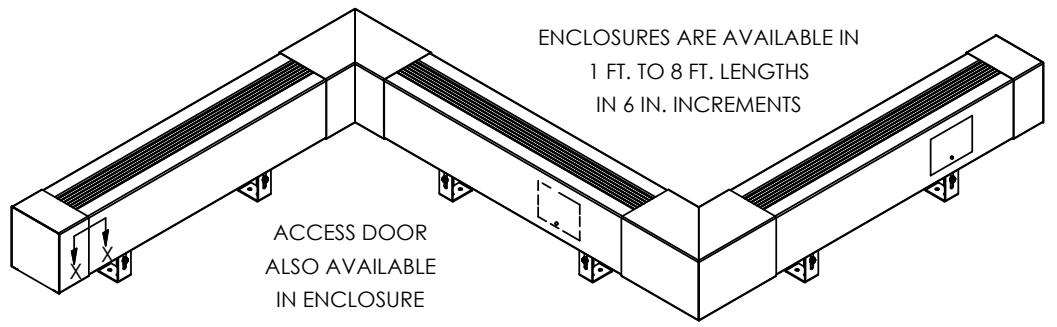

ACCESS DOOR
ALSO AVAILABLE
IN ENCLOSURE

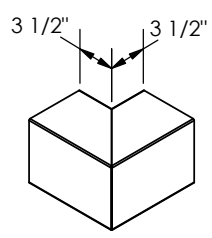
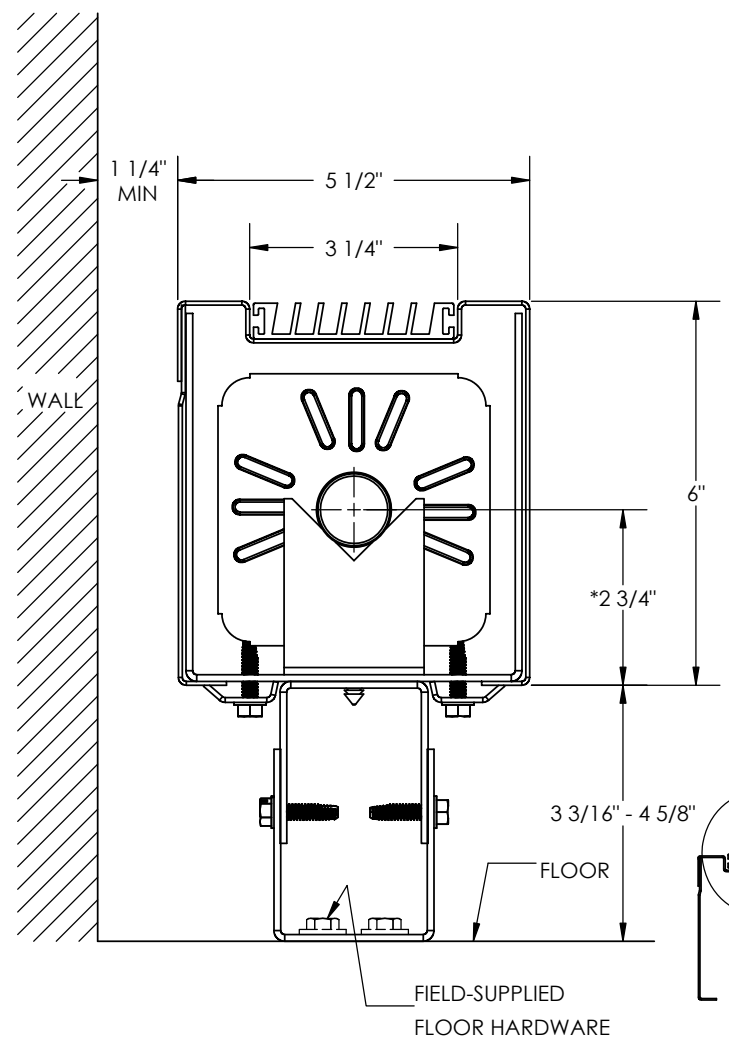

"OC"
OUTSIDE CORNER

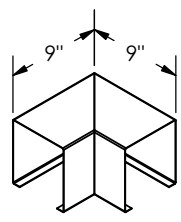

"IC"
INSIDE CORNER

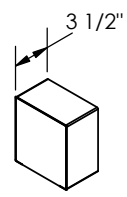

"EC"
END CAP
(LEFT HAND SHOWN)

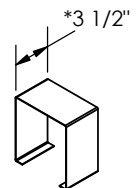

"WT"
WALL TRIP STRIP
*3-1/2", 5", 7-1/2"

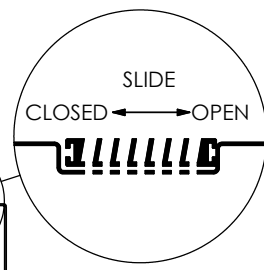

SLIDE DAMPER OPTION

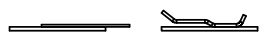

SECTION X-X
INTERNAL JOGGLE-JOINER

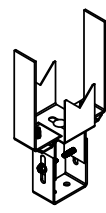

"PED - ADJ"
PEDESTAL 506 1 ROW
ADJUSTABLE BRACKET

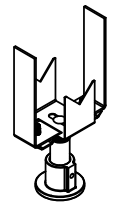

"PED - ALU"
PEDESTAL 506 1 ROW
ALUM FLANGE BRACKET

*CENTERLINES BASED ON 1" COPPER TUBE
4-1/4" SQ FIN SHOWN

NOTE:
1) ALL ACCESSORIES OVERLAP

CONTRACTOR _____	ELEMENT _____
ARCHITECT _____	RATING _____ B.T.U. _____ A.W.T. _____ E.A.T.
ENGINEER _____	BACKPLATE _____ FULL _____ PARTIAL _____
REPRESENTATIVE _____	ENCL. GAUGE _____ MATERIAL _____
LOCATION _____	COLOR _____ DAMPER _____

zehnder		BUFFALO, NEW YORK 14220	
MODEL: PIBG506		MATERIAL:	
JOB:		REVISION: -	DWN BY:
DWG. NO.		DATE: May 2018	

ENCLOSURES ARE AVAILABLE IN
1 FT. TO 8 FT. LENGTHS
IN 6 IN. INCREMENTS

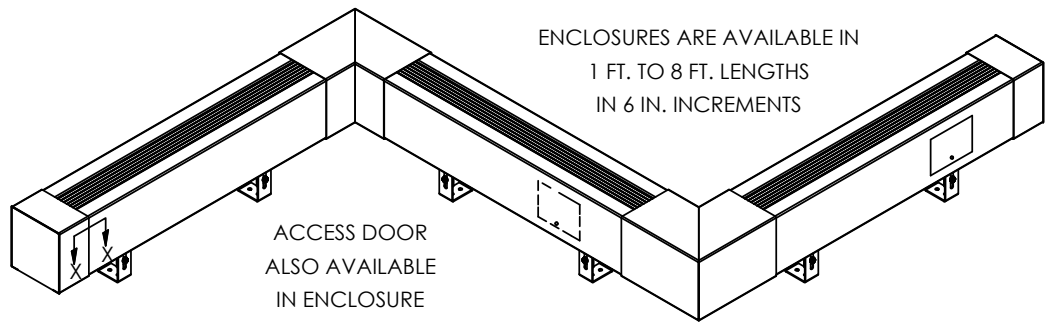

ACCESS DOOR
ALSO AVAILABLE
IN ENCLOSURE

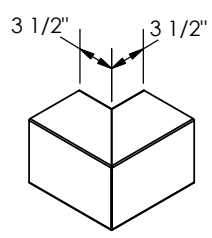
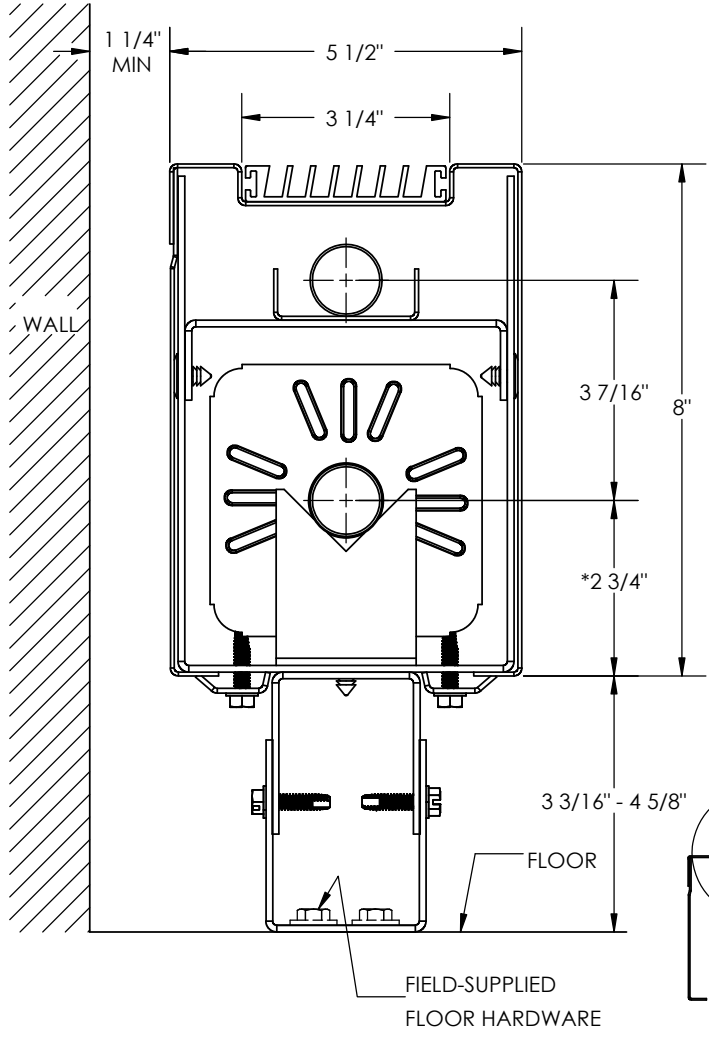

"OC"
OUTSIDE CORNER

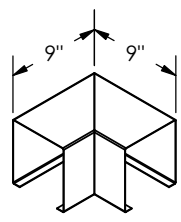

"IC"
INSIDE CORNER

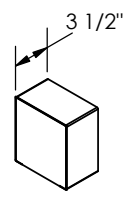

"EC"
END CAP
(LEFT HAND SHOWN)

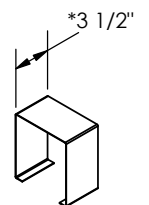

"WT"
WALL TRIP STRIP
*3-1/2", 5", 7-1/2"

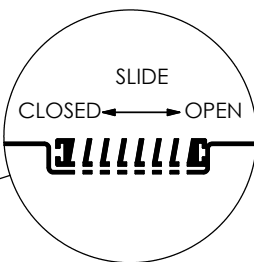

SLIDE DAMPER OPTION

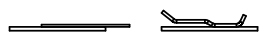

SECTION X-X
INTERNAL JOGGLE-JOINER



"PED - ADJ"
PEDESTAL 508 1 ROW
ADJUSTABLE BRACKET

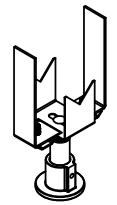

"PED - ALU"
PEDESTAL 508 1 ROW
ALUM FLANGE BRACKET

*CENTERLINES BASED ON 1" COPPER TUBE
4-1/4" SQ FIN SHOWN

NOTE:
1) ALL ACCESSORIES OVERLAP

CONTRACTOR _____	ELEMENT _____
ARCHITECT _____	RATING _____ B.T.U. _____ A.W.T. _____ E.A.T.
ENGINEER _____	BACKPLATE _____ FULL _____ PARTIAL _____
REPRESENTATIVE _____	ENCL. GAUGE _____ MATERIAL _____
LOCATION _____	COLOR _____ DAMPER _____

zehnder		BUFFALO, NEW YORK 14220	
MODEL: PIBG508 with RETURN		MATERIAL:	
JOB:		REVISION: -	DWN BY:
DWG. NO.		DATE: May 2018	

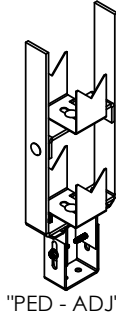
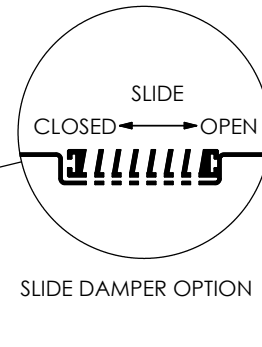
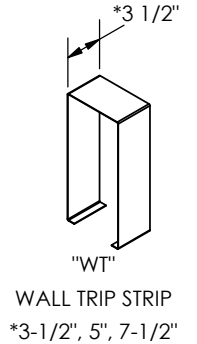
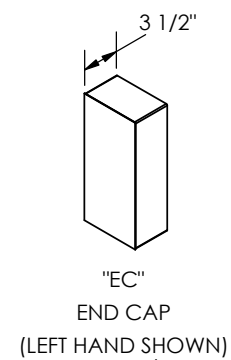
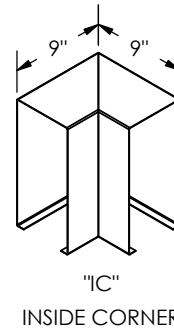
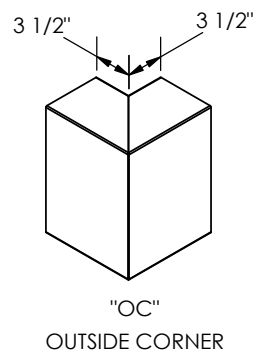
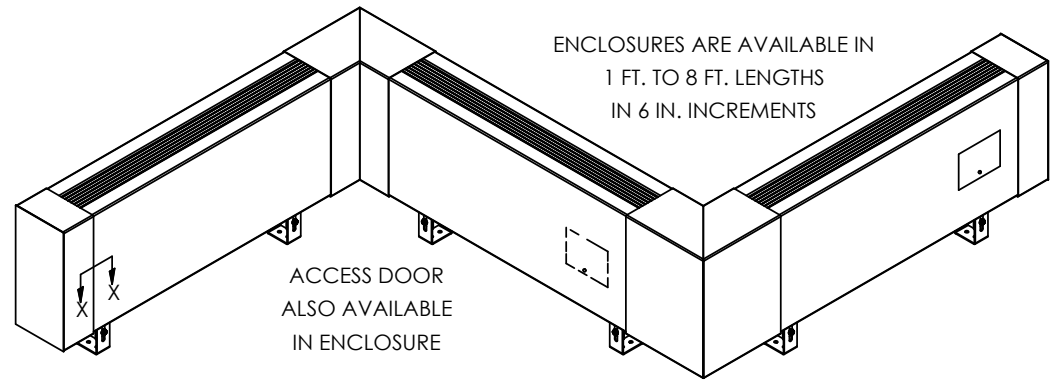
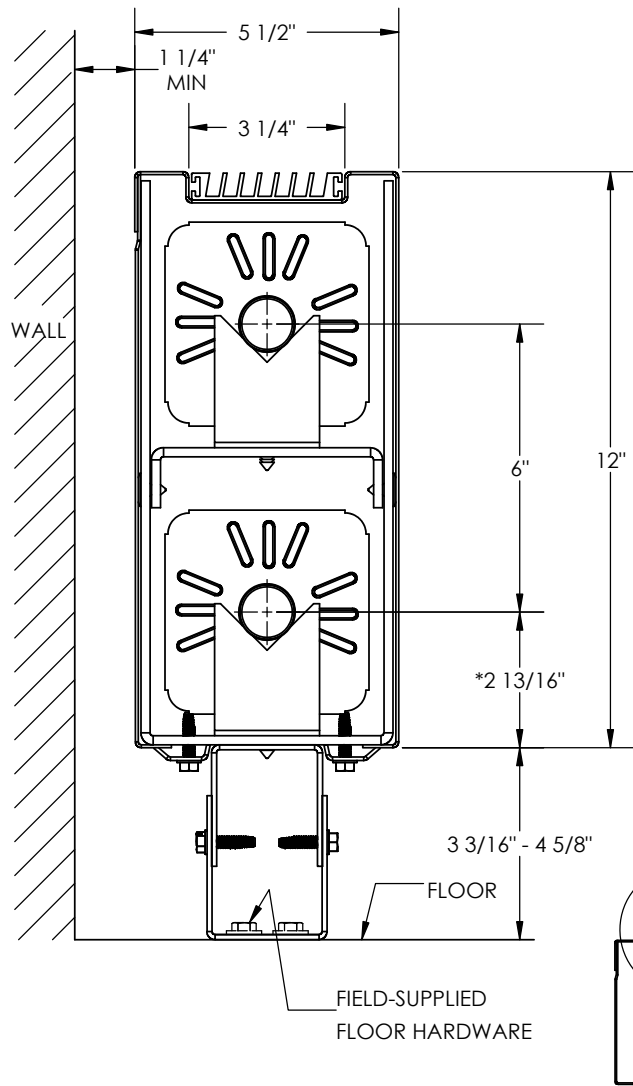

PEDESTAL 512 2 ROW ADJUSTABLE BRACKET

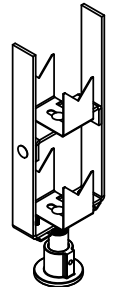

PEDESTAL 512 2 ROW ALUM FLANGE BRACKET

*CENTERLINES BASED ON 1" COPPER TUBE
4-1/4" SQ FIN SHOWN

NOTE:
1) ALL ACCESSORIES OVERLAP

CONTRACTOR _____	ELEMENT _____
ARCHITECT _____	RATING _____ B.T.U. _____ A.W.T. _____ E.A.T. _____
ENGINEER _____	BACKPLATE _____ FULL _____ PARTIAL _____
REPRESENTATIVE _____	ENCL. GAUGE _____ MATERIAL _____
LOCATION _____	COLOR _____ DAMPER _____

zehnder

**BUFFALO,
NEW YORK 14220**

MODEL: PIBG512	MATERIAL:
JOB:	REVISION: -
DWG. NO.	DWN BY: -
	DATE: May 2018

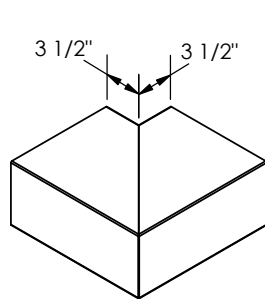
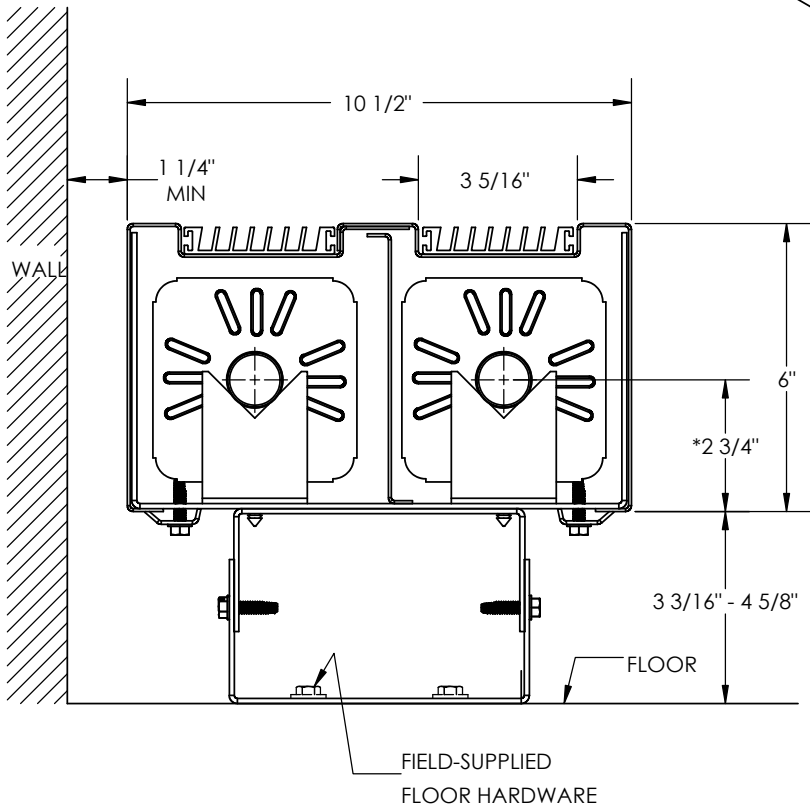
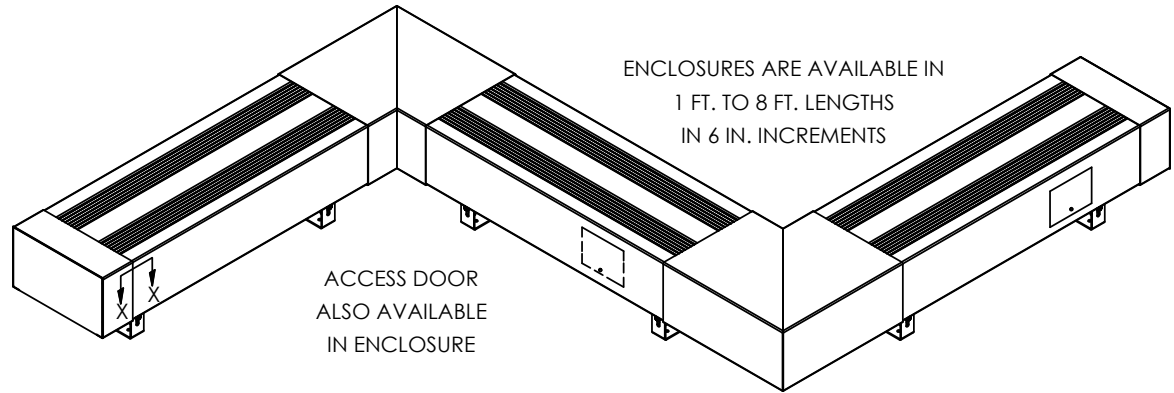

"OC"
OUTSIDE CORNER

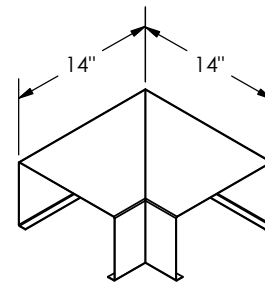

"IC"
INSIDE CORNER

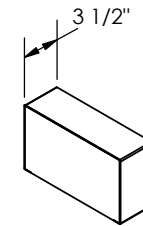

"EC"
END CAP
(LEFT HAND SHOWN)

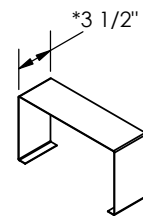

"WT"
WALL TRIP STRIP
*3-1/2", 5", 7-1/2"

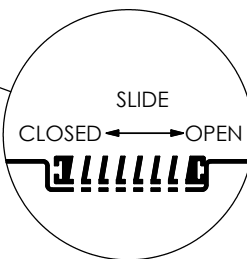
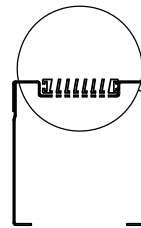

SLIDE DAMPER OPTION



SECTION X-X
INTERNAL JOGGLE-JOINER

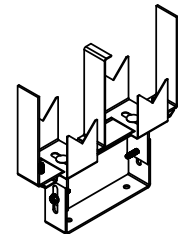

"PED - ADJ"
PEDESTAL 1006 2 COLUMN
ADJUSTABLE BRACKET

*CENTERLINES BASED ON 1" COPPER TUBE
4-1/4" SQ FIN SHOWN

NOTE:
1) ALL ACCESSORIES OVERLAP

CONTRACTOR _____	ELEMENT _____
ARCHITECT _____	RATING _____ B.T.U. _____ A.W.T. _____ E.A.T. _____
ENGINEER _____	BACKPLATE _____ FULL _____ PARTIAL _____
REPRESENTATIVE _____	ENCL. GAUGE _____ MATERIAL _____
LOCATION _____	COLOR _____ DAMPER _____

zehnder

**BUFFALO,
NEW YORK 14220**

MODEL: PIBG1006	MATERIAL:	
JOB:	REVISION: -	DWN BY:
DWG. NO.	DATE: May 2018	

ENCLOSURES ARE AVAILABLE IN
1 FT. TO 8 FT. LENGTHS
IN 6 IN. INCREMENTS

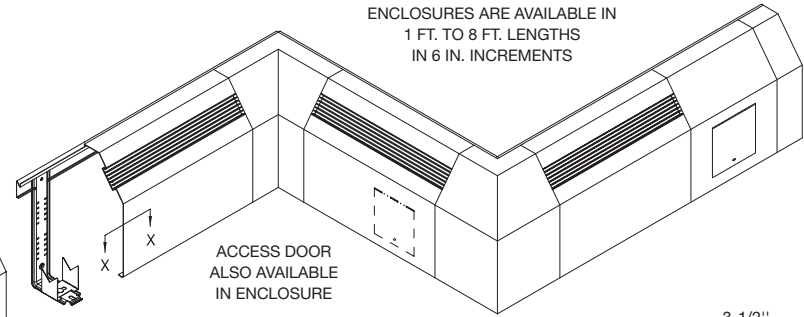

ACCESS DOOR
ALSO AVAILABLE
IN ENCLOSURE

ACCESSORIES

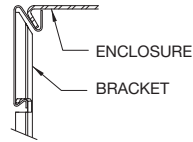

SNAP MOUNTING
CHANNEL DETAIL

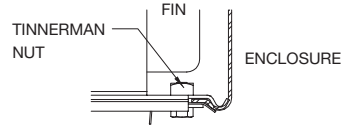

DETAIL OF ENCLOSURE
BOTTOM MOUNTING CLIP

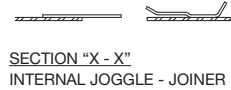

SECTION "X - X"
INTERNAL JOGGLE - JOINER

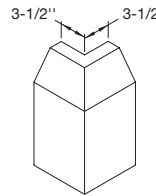
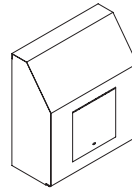

"OC"
OUTSIDE CORNER



"SNEXP"
SNAP ENCLOSURE
EXPANSION BRACKET



"SLSRB"
SLIP - IN SECOND
ROW BRACKET



"SLPH"
SLIP - IN PIPE
HANGER

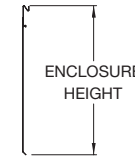

"SNFBP"
SNAP FULL
BACK PANEL

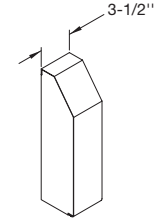

"EC"
END CAP
(LEFT HAND SHOWN)

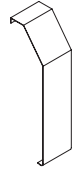

"WT"
WALL TRIM STRIP
3-1/2", 5", 7-1/2"

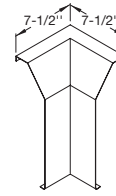

"IC"
INSIDE CORNER

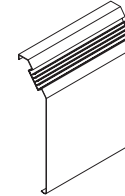

"AS"
REMOVABLE
ENCLOSURE SECTION
BUTT TYPE STYLE ONLY
NO JOGGLES OR JOINERS

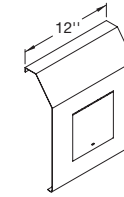

"AP"
ACCESS PANEL
WITH ACCESS DOOR,
(SECURITY LOCK OPT.)

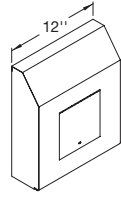

"AC"
END CAP
WITH ACCESS DOOR,
LEFT SIDE SHOWN
(SECURITY LOCK OPT.)

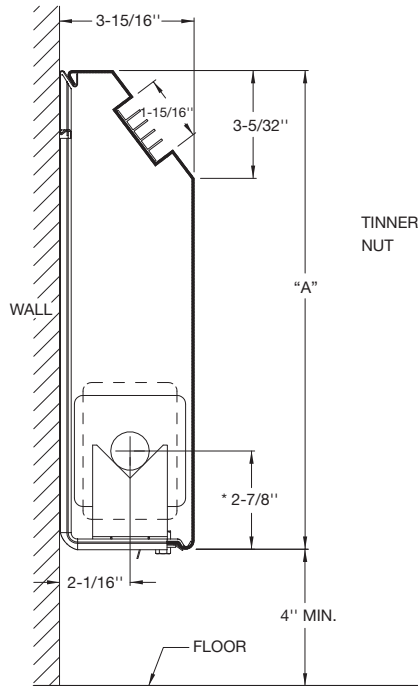

* CENTERLINES BASED ON 1" COPPER TUBE



"WS"
WALL TRIM SUPPORT

MODEL	PIPE SIZE		FIN SIZE	A
	STEEL	COPPER		
SBG3	N/A	3/4", 1", 1-1/4"	2-3/4" x 4"	8
	1", 1-1/4"	3/4", 1", 1-1/4"	3-1/4" x 3-1/4"	11
				14

NOTE:
1) ALL ACCESSORIES OVERLAP
(EXCEPT AS NOTED)
2) BUTT TYPE (INTERLOCKING) STYLE OPTIONAL
(EXCEPT AS NOTED)



CONTRACTOR _____ ELEMENT _____
 ARCHITECT _____ RATING _____ BTU _____ A.W.T. _____ E.A.T. _____
 ENGINEER _____ BACKPLATE _____ FULL _____ PARTIAL _____
 REPRESENTATIVE _____ ENCL. GAUGE _____ MATERIAL _____
 LOCATION _____ COLOR _____ DAMPER _____

ZEHNDER RITTLING
100 RITTLING BLVD. • BUFFALO, NY USA 14220

JOB:

ENCLOSURE MODEL: **SBG3**

DATE: **January 2011**

DWG.NO.: **SBG3**

ENCLOSURES ARE AVAILABLE IN
1 FT. TO 8 FT. LENGTHS
IN 6 IN. INCREMENTS

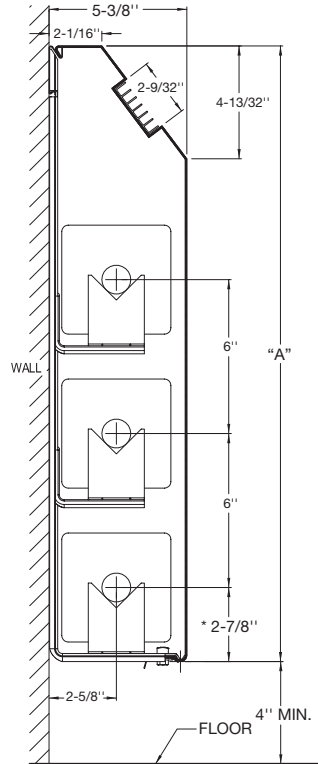

* CENTERLINES BASED ON 1" COPPER TUBE

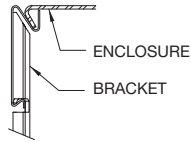

SNAP MOUNTING CHANNEL DETAIL

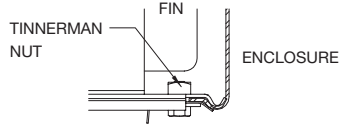

DETAIL OF ENCLOSURE BOTTOM MOUNTING CLIP



SECTION "X - X" INTERNAL JOGGLE - JOINER

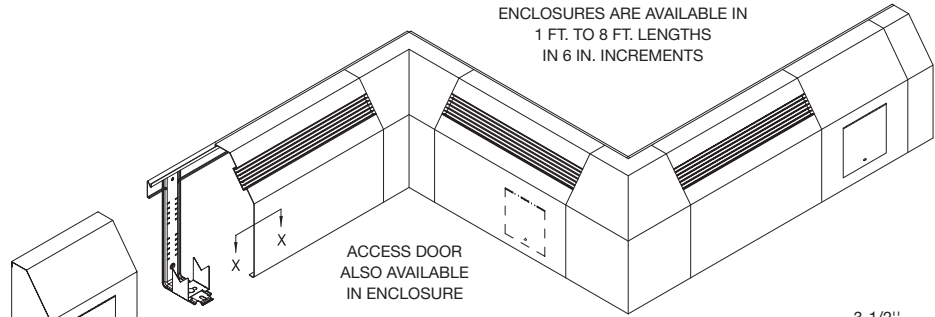

ACCESS DOOR ALSO AVAILABLE IN ENCLOSURE

ACCESSORIES

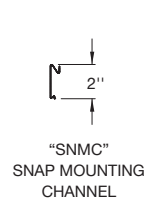

"SNMC" SNAP MOUNTING CHANNEL

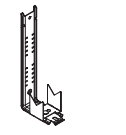

"SNEXP" SNAP ENCLOSURE EXPANSION BRACKET



"SLSRB" SLIP - IN SECOND ROW BRACKET



"SLPH" SLIP - IN PIPE HANGER

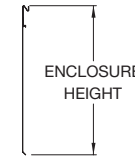

"SNFBP" SNAP FULL BACK PANEL

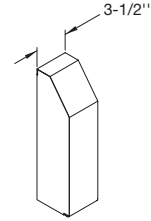

"EC" END CAP (LEFT HAND SHOWN)

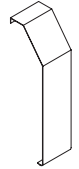

"WT" WALL TRIM STRIP 3-1/2", 5", 7-1/2"

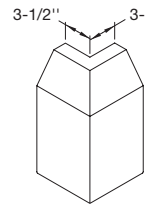

"OC" OUTSIDE CORNER

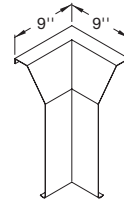

"IC" INSIDE CORNER

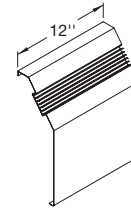

"AS" REMOVABLE ENCLOSURE SECTION BUTT TYPE STYLE ONLY NO JOGGLES OR JOINERS

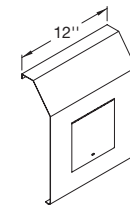

"AP" ACCESS PANEL WITH ACCESS DOOR, (SECURITY LOCK OPT.)

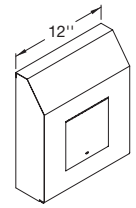

"AC" END CAP WITH ACCESS DOOR, LEFT SIDE SHOWN (SECURITY LOCK OPT.)



"WS" WALL TRIM SUPPORT

MODEL	PIPE SIZE		FIN SIZE	A
	STEEL	COPPER		
SBG5	N/A	3/4", 1", 1-1/4"	2-3/4" x 4"	14
	1", 1-1/4"	3/4", 1", 1-1/4"	3-1/4", x 3-1/4"	20
	1", 1-1/4", 2"	3/4", 1", 1-1/4"	4-1/4" x 4-1/4"	24

NOTE:
1) ALL ACCESSORIES OVERLAP (EXCEPT AS NOTED)
2) BUTT TYPE (INTERLOCKING) STYLE OPTIONAL (EXCEPT AS NOTED)



CONTRACTOR _____ ELEMENT _____
 ARCHITECT _____ RATING _____ BTU _____ A.W.T. _____ E.A.T. _____
 ENGINEER _____ BACKPLATE _____ FULL _____ PARTIAL _____
 REPRESENTATIVE _____ ENCL. GAUGE _____ MATERIAL _____
 LOCATION _____ COLOR _____ DAMPER _____

ZEHNDER RITTLING
100 RITTLING BLVD. • BUFFALO, NY USA 14220

JOB:

ENCLOSURE MODEL: **SBG5**

DATE: **January 2011**

DWG.NO.: **SBG5**

ENCLOSURES ARE AVAILABLE IN
1 FT. TO 8 FT. LENGTHS
IN 6 IN. INCREMENTS

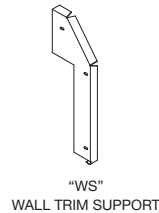
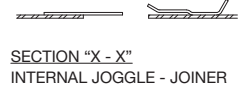
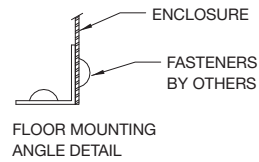
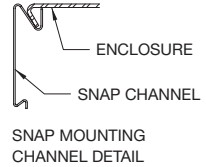
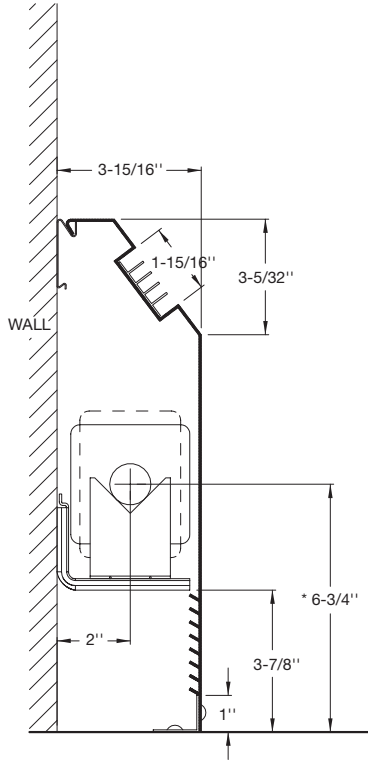
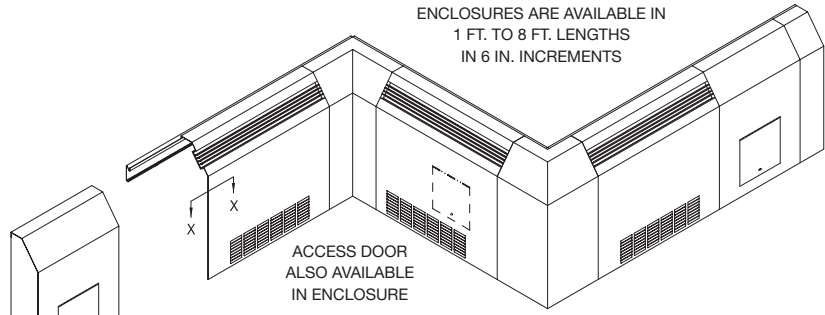

ACCESSORIES

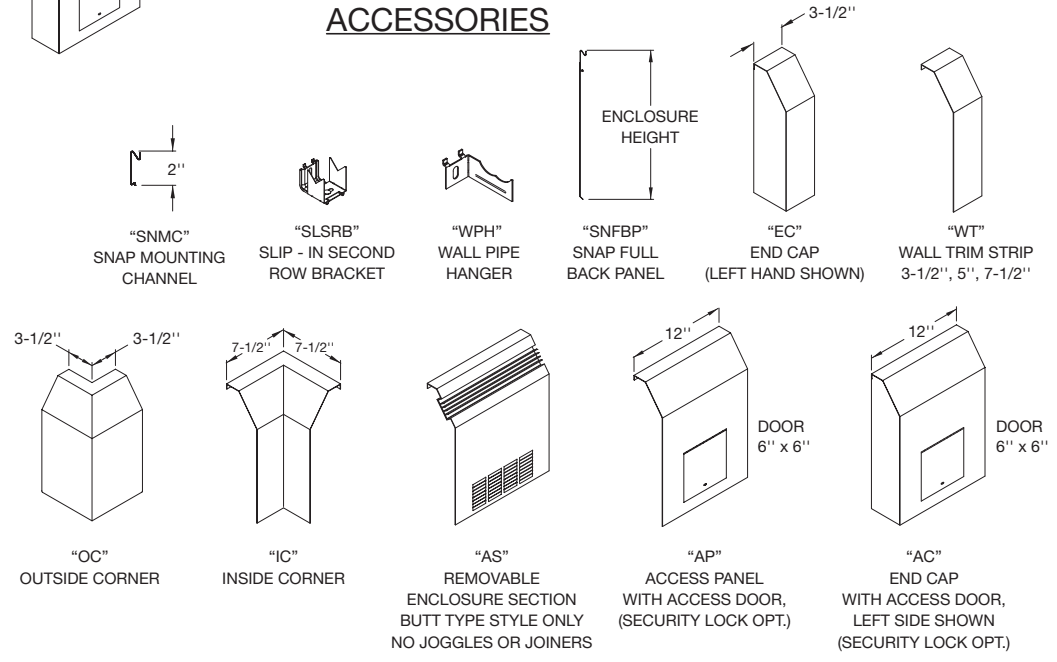

* CENTERLINES BASED ON 1" COPPER TUBE

NOTE:
1) ALL ACCESSORIES OVERLAP (EXCEPT AS NOTED)
2) BUTT TYPE (INTERLOCKING) STYLE OPTIONAL (EXCEPT AS NOTED)
3) CONSULT FACTORY ON DAMPER AVAILABILITY



MODEL	PIPE SIZE		FIN SIZE	A
	STEEL	COPPER		
SBGVL3	N/A	3/4", 1", 1-1/4"	2-3/4" x 4"	14
	1", 1-1/4"	3/4", 1", 1-1/4"	3-1/4" x 3-1/4"	

CONTRACTOR _____	ELEMENT _____	ZEHNDER RITTLING 100 RITTLING BLVD. • BUFFALO, NY USA 14220
ARCHITECT _____	RATING _____ BTU _____ A.W.T. _____ E.A.T. _____	JOB: _____
ENGINEER _____	BACKPLATE _____ FULL _____ PARTIAL _____	ENCLOSURE MODEL: SBGVL3
REPRESENTATIVE _____	ENCL. GAUGE _____ MATERIAL _____	DATE: January 2011
LOCATION _____	COLOR _____ DAMPER _____	DWG.NO.: SBGVL3

ENCLOSURES ARE AVAILABLE IN
1 FT. TO 8 FT. LENGTHS
IN 6 IN. INCREMENTS

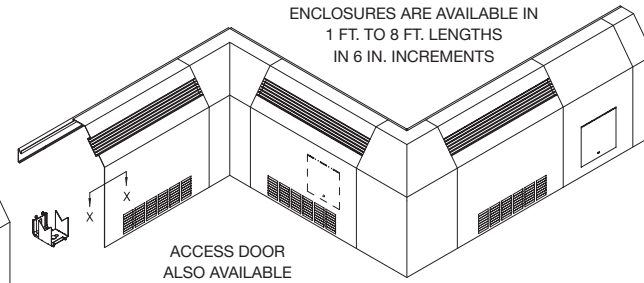

ACCESS DOOR
ALSO AVAILABLE
IN ENCLOSURE

ACCESSORIES

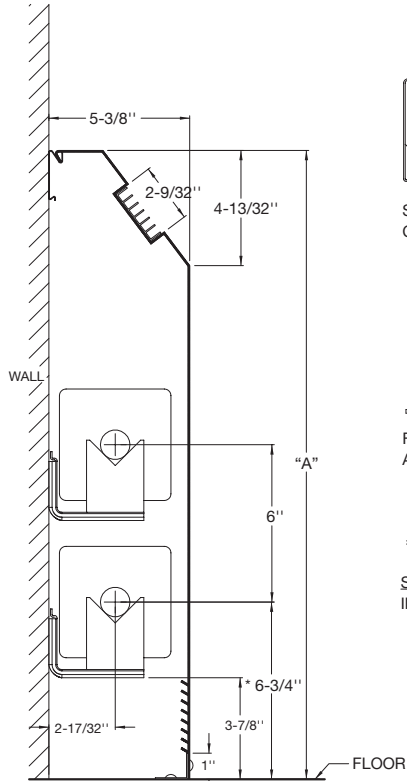

* CENTERLINES BASED ON 1" COPPER TUBE

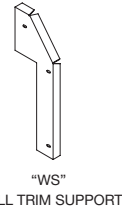
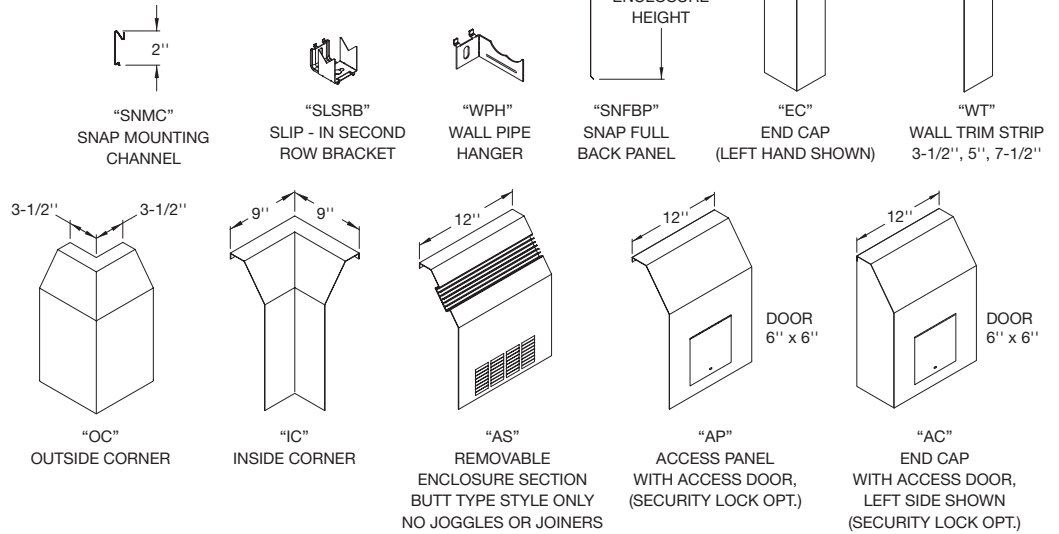

NOTE:
1) ALL ACCESSORIES OVERLAP (EXCEPT AS NOTED)
2) BUTT TYPE (INTERLOCKING) STYLE OPTIONAL (EXCEPT AS NOTED)
3) CONSULT FACTORY ON DAMPER AVAILABILITY



MODEL	PIPE SIZE		FIN SIZE	A
	STEEL	COPPER		
SBGVL5	N/A	3/4", 1", 1-1/4"	2-3/4" x 4"	14
	1", 1-1/4"	3/4", 1", 1-1/4"	3-1/4", x 3-1/4"	20
	1", 1-1/4", 2"	3/4", 1", 1-1/4"	4-1/4" x 4-1/4"	24

CONTRACTOR _____ ELEMENT _____

ARCHITECT _____ RATING _____ BTU _____ A.W.T. _____ E.A.T. _____

ENGINEER _____ BACKPLATE _____ FULL _____ PARTIAL _____

REPRESENTATIVE _____ ENCL. GAUGE _____ MATERIAL _____

LOCATION _____ COLOR _____ DAMPER _____

ZEHNDER RITTLING
100 RITTLING BLVD. • BUFFALO, NY USA 14220

JOB:

ENCLOSURE MODEL: **SBGVL5**

DATE: **January 2011**

DWG.NO.: **SBGVL5**

ENCLOSURES ARE AVAILABLE IN
1 FT. TO 8 FT. LENGTHS
IN 6 IN. INCREMENTS

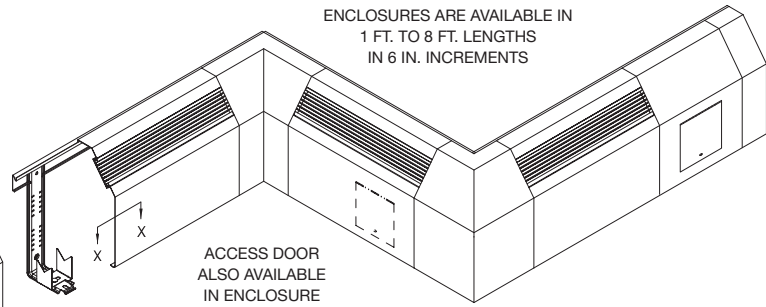

ACCESS DOOR
ALSO AVAILABLE
IN ENCLOSURE

ACCESSORIES

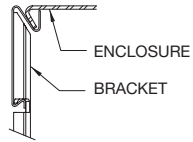

SNAP MOUNTING
CHANNEL DETAIL

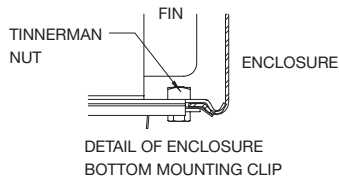

DETAIL OF ENCLOSURE
BOTTOM MOUNTING CLIP



SECTION "X - X"
INTERNAL JOGGLE - JOINER

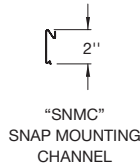

"SNMC"
SNAP MOUNTING
CHANNEL



"SNEXP"
SNAP ENCLOSURE
EXPANSION BRACKET



"SLSRB"
SLIP - IN SECOND
ROW BRACKET



"SLPH"
SLIP - IN PIPE
HANGER

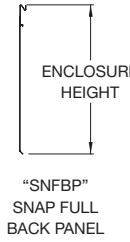

"SNFBP"
SNAP FULL
BACK PANEL

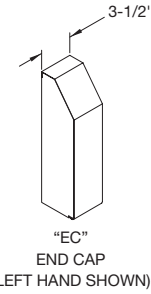

"EC"
END CAP
(LEFT HAND SHOWN)

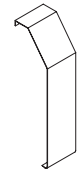

"WT"
WALL TRIM STRIP
3-1/2", 5", 7-1/2"

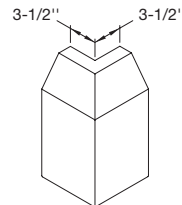

"OC"
OUTSIDE CORNER

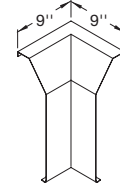

"IC"
INSIDE CORNER

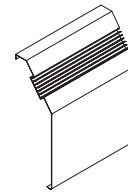

"AS"
REMOVABLE
ENCLOSURE SECTION
BUTT TYPE STYLE ONLY
NO JOGGLES OR JOINERS

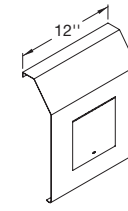

"AP"
ACCESS PANEL
WITH ACCESS DOOR,
(SECURITY LOCK OPT.)

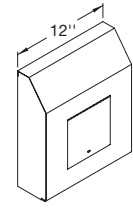

"AC"
END CAP
WITH ACCESS DOOR,
LEFT SIDE SHOWN
(SECURITY LOCK OPT.)

NOTE:
1) ALL ACCESSORIES OVERLAP
(EXCEPT AS NOTED)
2) BUTT TYPE (INTERLOCKING) STYLE OPTIONAL
(EXCEPT AS NOTED)

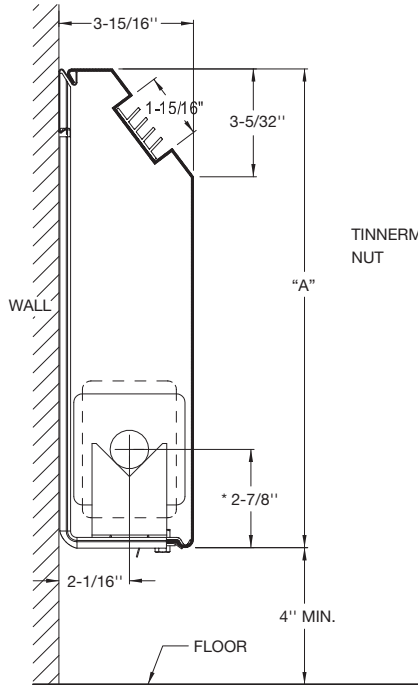

* CENTERLINES BASED ON 1" COPPER TUBE

MODEL	PIPE SIZE		FIN SIZE	A
	STEEL	COPPER		
SIBG3	N/A	3/4", 1", 1-1/4"	2-3/4" x 4"	8
	1", 1-1/4"	3/4", 1", 1-1/4"	3-1/4" x 3-1/4"	11
	1", 1-1/4"	3/4", 1", 1-1/4"	3-1/4" x 3-1/4"	14

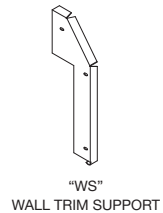

"WS"
WALL TRIM SUPPORT

CONTRACTOR _____ ELEMENT _____

ARCHITECT _____ RATING _____ BTU _____ A.W.T. _____ E.A.T. _____

ENGINEER _____ BACKPLATE _____ FULL _____ PARTIAL _____

REPRESENTATIVE _____ ENCL. GAUGE _____ MATERIAL _____

LOCATION _____ COLOR _____ DAMPER _____

ZEHNDER RITTLING
100 RITTLING BLVD. • BUFFALO, NY USA 14220

JOB:

ENCLOSURE MODEL: **SIBG3**

DATE: **January 2011**

DWG.NO.: **SIBG3**

zehnder

Rittling

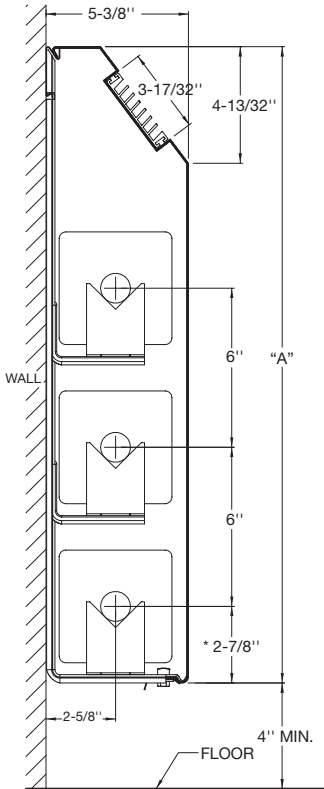

* CENTERLINES BASED ON 1" COPPER TUBE

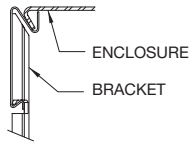

SNAP MOUNTING CHANNEL DETAIL

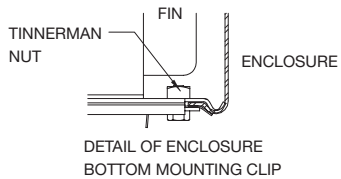

DETAIL OF ENCLOSURE BOTTOM MOUNTING CLIP

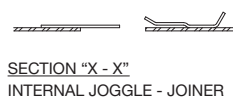

SECTION "X - X" INTERNAL JOGGLE - JOINER

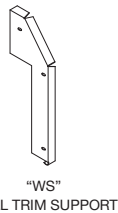

"WS" WALL TRIM SUPPORT

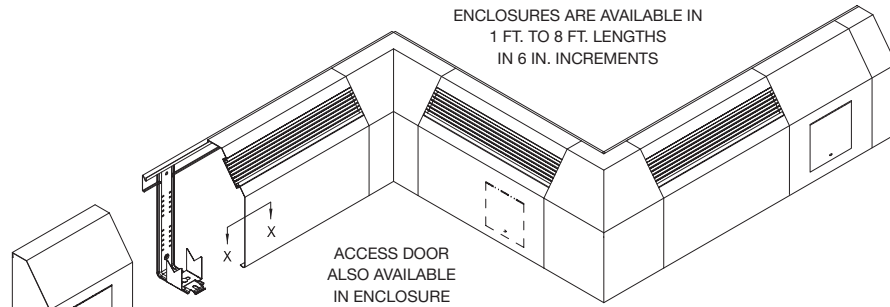

ENCLOSURES ARE AVAILABLE IN 1 FT. TO 8 FT. LENGTHS IN 6 IN. INCREMENTS

ACCESS DOOR ALSO AVAILABLE IN ENCLOSURE

ACCESSORIES

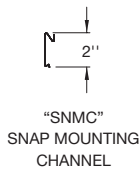

"SNMC" SNAP MOUNTING CHANNEL



"SNEXP" SNAP ENCLOSURE EXPANSION BRACKET



"SLSRB" SLIP - IN SECOND ROW BRACKET



"SLPH" SLIP - IN PIPE HANGER

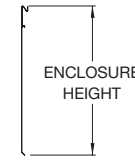

"SNFBP" SNAP FULL BACK PANEL

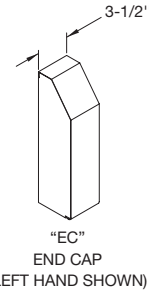

"EC" END CAP (LEFT HAND SHOWN)

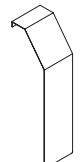

"WT" WALL TRIM STRIP 3-1/2", 5", 7-1/2"

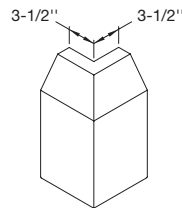

"OC" OUTSIDE CORNER

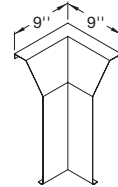

"IC" INSIDE CORNER

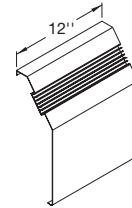

"AS" REMOVABLE ENCLOSURE SECTION BUTT TYPE STYLE ONLY NO JOGGLES OR JOINERS

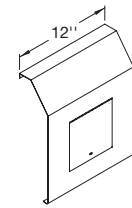

"AP" ACCESS PANEL WITH ACCESS DOOR, (SECURITY LOCK OPT.)

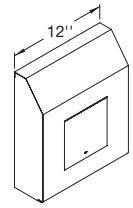

"AC" END CAP WITH ACCESS DOOR, LEFT SIDE SHOWN (SECURITY LOCK OPT.)

NOTE:
1) ALL ACCESSORIES OVERLAP (EXCEPT AS NOTED)
2) BUTT TYPE (INTERLOCKING) STYLE OPTIONAL (EXCEPT AS NOTED)



MODEL	PIPE SIZE		FIN SIZE	A
	STEEL	COPPER		
SIBG5	N/A	3/4", 1", 1-1/4"	2-3/4" x 4"	14"
	1", 1-1/4"	3/4", 1", 1-1/4"	3-1/4", x 3-1/4"	20"
	1", 1-1/4", 2"	3/4", 1", 1-1/4"	4-1/4" x 4-1/4"	24"

CONTRACTOR _____ ELEMENT _____

ARCHITECT _____ RATING _____ BTU _____ A.W.T. _____ E.A.T. _____

ENGINEER _____ BACKPLATE _____ FULL _____ PARTIAL _____

REPRESENTATIVE _____ ENCL. GAUGE _____ MATERIAL _____

LOCATION _____ COLOR _____ DAMPER _____

ZEHNDER RITTLING
100 RITTLING BLVD. • BUFFALO, NY USA 14220

JOB:

ENCLOSURE MODEL: **SIBG5**

DATE: **January 2011**

DWG.NO.: **SIBG5**

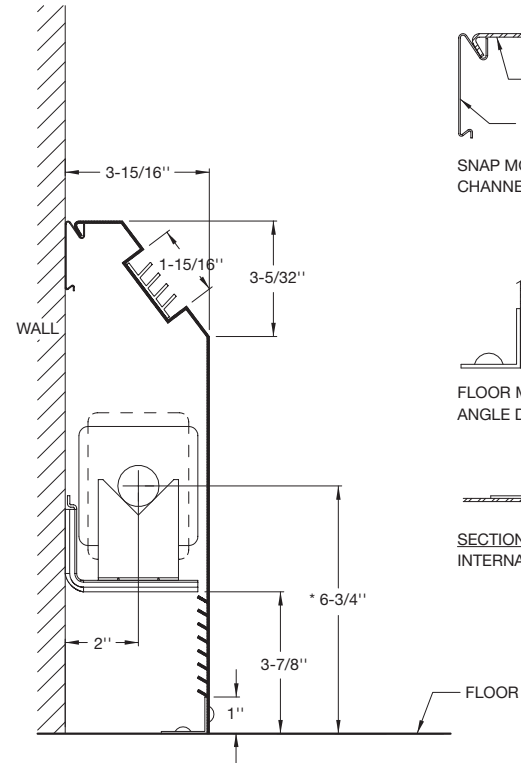

* CENTERLINES BASED ON 1" COPPER TUBE

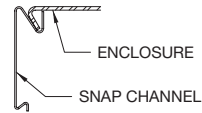

SNAP MOUNTING CHANNEL DETAIL

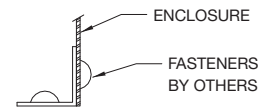

FLOOR MOUNTING ANGLE DETAIL

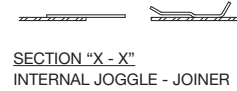

SECTION "X - X" INTERNAL JOGGLE - JOINER



"WS" WALL TRIM SUPPORT

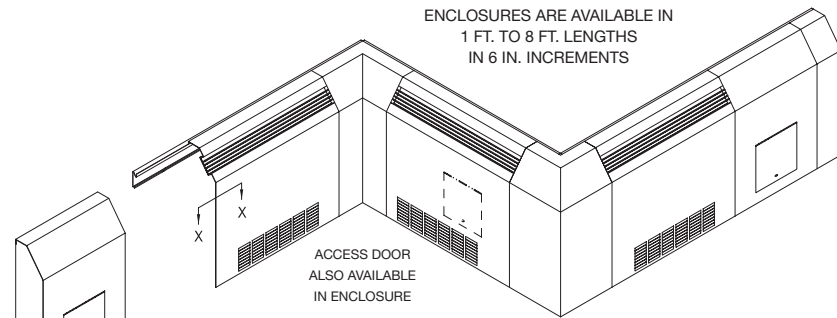

ACCESSORIES

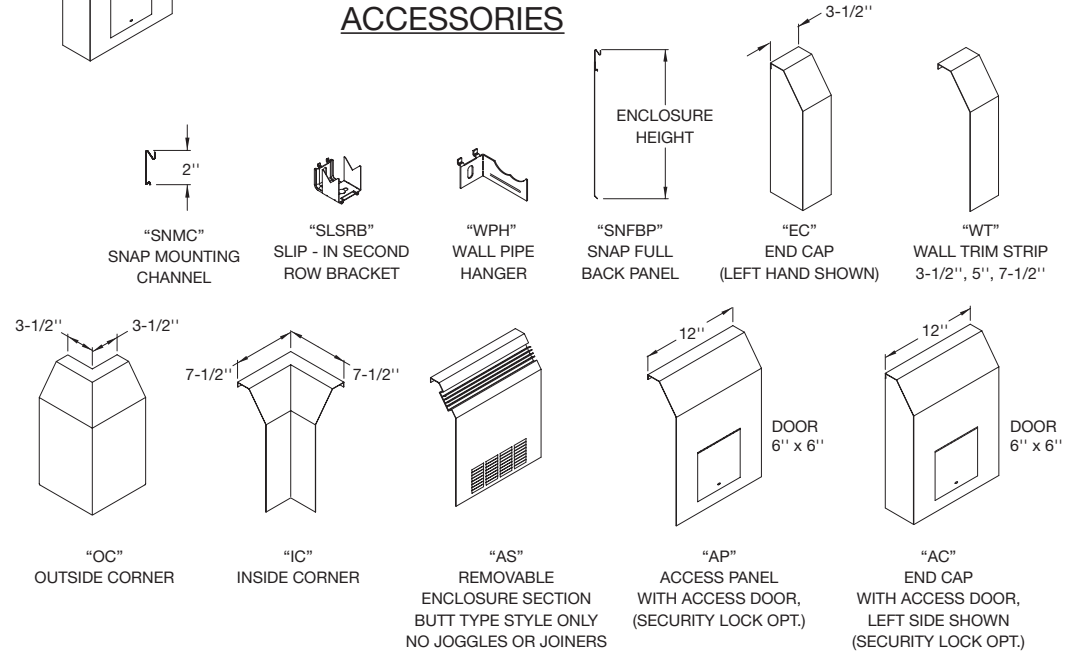

- NOTE:
 1) ALL ACCESSORIES OVERLAP (EXCEPT AS NOTED)
 2) BUTT TYPE (INTERLOCKING) STYLE OPTIONAL (EXCEPT AS NOTED)
 3) CONSULT FACTORY ON DAMPER AVAILABILITY



MODEL	PIPE SIZE		FIN SIZE	A
	STEEL	COPPER		
SIBGVL3	N/A	3/4", 1", 1-1/4"	2-3/4" x 4"	14"
	1", 1-1/4"	3/4", 1", 1-1/4"	3-1/4" x 3-1/4"	

CONTRACTOR _____ ELEMENT _____

ARCHITECT _____ RATING _____ BTU _____ A.W.T. _____ E.A.T. _____

ENGINEER _____ BACKPLATE _____ FULL _____ PARTIAL _____

REPRESENTATIVE _____ ENCL. GAUGE _____ MATERIAL _____

LOCATION _____ COLOR _____ DAMPER _____

ZEHNDER RITTLING
 100 RITTLING BLVD. • BUFFALO, NY USA 14220

JOB:

ENCLOSURE MODEL: **SIBGVL3**

DATE: **January 2011**

DWG.NO.: **SIBGVL3**

ENCLOSURES ARE AVAILABLE IN
1 FT. TO 8 FT. LENGTHS
IN 6 IN. INCREMENTS

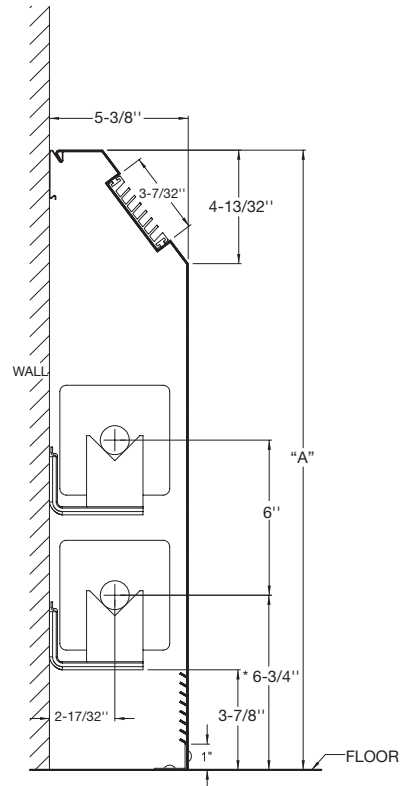

* CENTERLINES BASED ON 1" COPPER TUBE

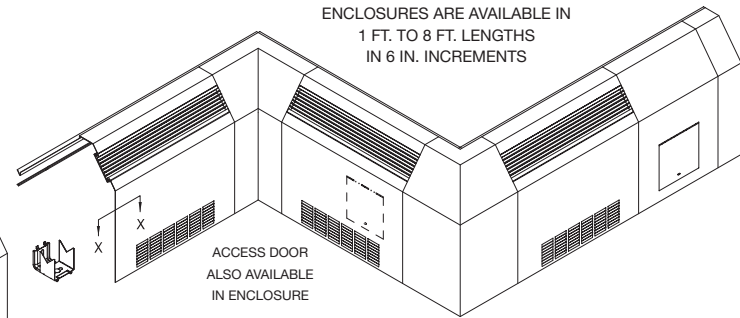
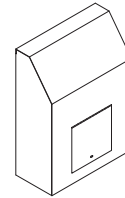
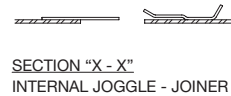
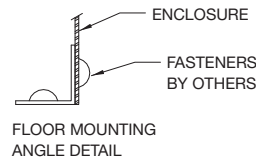
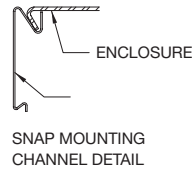

ACCESSORIES

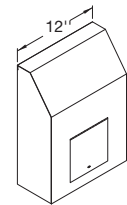
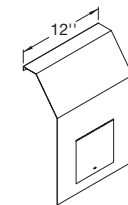
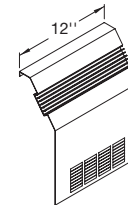
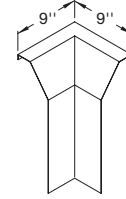
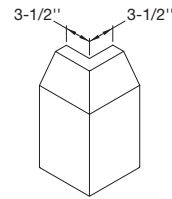
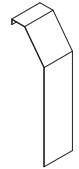
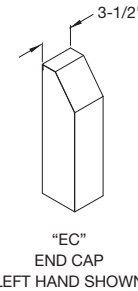
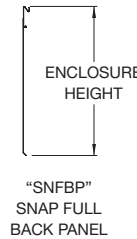
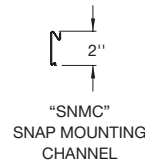

"OC" OUTSIDE CORNER

"IC" INSIDE CORNER

"AS" REMOVABLE ENCLOSURE SECTION BUTT TYPE STYLE ONLY NO JOGGLES OR JOINERS

"AP" ACCESS PANEL WITH ACCESS DOOR, (SECURITY LOCK OPT.)

"AC" END CAP WITH ACCESS DOOR, LEFT SIDE SHOWN (SECURITY LOCK OPT.)

"WS" WALL TRIM SUPPORT

- NOTE:
1) ALL ACCESSORIES OVERLAP (EXCEPT AS NOTED)
2) BUTT TYPE (INTERLOCKING) STYLE OPTIONAL (EXCEPT AS NOTED)
3) CONSULT FACTORY ON DAMPER AVAILABILITY



MODEL	PIPE SIZE		FIN SIZE	A
	STEEL	COPPER		
SIBGVL5	N/A	3/4", 1", 1-1/4"	2-3/4" x 4"	14"
	1", 1-1/4"	3/4", 1", 1-1/4"	3-1/4", x 3-1/4"	20"
	1", 1-1/4", 2"	3/4", 1", 1-1/4"	4-1/4" x 4-1/4"	24"

CONTRACTOR _____ ELEMENT _____

ARCHITECT _____ RATING _____ BTU _____ A.W.T. _____ E.A.T. _____

ENGINEER _____ BACKPLATE _____ FULL _____ PARTIAL _____

REPRESENTATIVE _____ ENCL. GAUGE _____ MATERIAL _____

LOCATION _____ COLOR _____ DAMPER _____

ZEHNDER RITTLING
100 RITTLING BLVD. • BUFFALO, NY USA 14220

JOB:

ENCLOSURE MODEL: **SIBGVL5**

DATE: **January 2011**

DWG.NO.: **SIBGVL5**